

AUTOMOTIVE INDUSTRY STANDARD

**CODE OF PRACTICE FOR
BUS BODY DESIGN AND APPROVAL
(First Revision)**



PRINTED BY
THE AUTOMOTIVE RESEARCH ASSOCIATION OF INDIA
P.B. NO. 832, PUNE 411 004
ON BEHALF OF
AUTOMOTIVE INDUSTRY STANDARDS COMMITTEE
UNDER
CENTRAL MOTOR VEHICLE RULES – TECHNICAL STANDING COMMITTEE
SET-UP BY
MINISTRY OF SHIPPING, ROAD TRANSPORT & HIGHWAYS
(DEPARTMENT OF ROAD TRANSPORT & HIGHWAYS)
GOVERNMENT OF INDIA
May 2017

INTRODUCTION

Our society's increasing requirements for mobility with simultaneously growing environmental sensitivity is a big challenge for the traffic policy makers and the transport corporations including private fleet operators. Consequently, it is also indispensable for the manufacturers of light and heavy passenger vehicles and the body builders to adapt to the ecologically motivated requirements, which becomes more and more important without compromising on basic minimum requirements of safety and comfort. The CMVR - Technical Standing Committee under the then Chairman Shri B. Bhanot, addressed the problem areas and the whole exercise was aimed towards standardizing the essential aspects involved in the construction of the bus body considering the minimum requirements of Safety and Comfort for a passenger.

Former Ministry of Surface Transport now called Ministry of Shipping, Road Transport & Highways, requested the CMVR-Technical Standing Committee to frame requisite guidelines on Standardization of the Bus Body. A Sub-Committee was formed under Mr. A. S. Lakra, the then Director-Engineering, of ASRTU to look into various aspects concerning Bus Body Design issue by the CMVR Committee. Series of meetings were held to deliberate on the issues and other sub-groups were set-up to deliberate and conclude on the relevant and critical technical issues. The Sub-Committee completed its task and the subject was finally discussed in the 10th CMVR-Technical Standing Committee meeting held on the 5th and 6th of July, 2001. The finalised “**Code of Practice for Bus Body Design and Approval**” was submitted to the Ministry for further necessary action. The standard AIS-052 was published in September 2001.

It was noticed that the OE vehicle manufacturers sell their products in the form of drive away chassis and the body design and building is being done by way side body builders who employ poor design, poor quality products, spurious materials and parts, with no uniformity in the construction, resulting in large amounts of fatal accidents. The existing bus body structures are hardly design optimal and safe. The cabin and seats have cramped designs which do not provide safety and comfort to the driver. Body designs offer extreme heat, vibration, noise, poor comfort and protection. Wood is being used in the construction of the body to a large extent. Of late some reputed body builders have brought in improved bus designs in the market but still a lot has to be done.

This exercise of formulation of the requisite guidelines was done for the first time in the country by involving various agencies including representatives of Transport Commissioner's offices and attempts were made to standardize certain required features concerned with the construction of a bus body. The Committee had looked into various aspects and after detailed deliberations of the issues the Code of Practice was formulated. The group had addressed the following critical areas besides other general aspects.

1. Categorization of buses based on the seating capacity and on minimum comfort levels and the type of operation.
2. Various safety related features like entry / exit door, emergency exits, window frames, their locations, dimensions and designs.
3. Standardization of the floor level height, gangways and dimensions of the foot steps.
4. Dimension of seats, seating layout, lighting and illumination.
5. Driver's workplace requirements.

6. Methodology for the calculation of the standing and seating capacity for the passengers.
7. Provisions for the persons with disabilities.
8. Stability and strength evaluations of the bus body structure, seat anchorages etc., including the roll over test for the full body.

The development of this Code was possible because of the commendable support and contributions made by the members of the Sub-Committee from ASRTU, ARAI, SIAM, CIRT, ACMA, representatives of others under the chairmanship of Mr. A. S. Lakra, the then Director - Engineering, ASRTU under the valuable direction and guidance of Shri B. Bhanot, the then Chairman-CMVR-TSC.

Further, the CMVR-Technical Standing Committee in its 21st meeting held on June 07, 2007 at New Delhi, realized the need for revision of the Bus Code and requested Shri Shrikant R. Marathe, Chairman-AISC to hold a separate sub-committee meeting with the stake holders for appropriate revision of the code. The specific concerns raised by the Vehicle industry, State Transport Corporations, and other stake holders were addressed in the meeting. Brihanmumbai Electric Supply and Transport (BEST), Metropolitan Transport Corporation (MTC), ARAI, CIRT, VRDE and SIAM participated in the discussions. The sub-committee discussed various issues raised by the stake holders, during the meeting held on July 30, 2007.

Further, as desired by the Chairman CMVR-TSC, during the special meeting on the Bus Code on March 08, 2008, at MOSRT&H, AISC had a separate meeting on April 04, 2008 at ARAI, specifically to discuss comments offered by Delhi Transport Corporation (DTC) and SIAM for concluding the recommendations.

There have been considerable changes in the ECE Regulation over a period of 7 years and the same had been considered for this revision exercise. The separate ECE Regulation 36 and 52 which was basically for the large capacity buses and small capacity buses have been put together to form ECE Regulation 107, which is common for all buses and coaches. The changes proposed by the stakeholders were examined in light of the revised Regulation ECE R 107, with a view to bring in more clarity on certain issues and to take care of editorial correction. The Midi and Mini buses which were addressed separately in our Bus Code have also been rationalized.

The changes have been duly incorporated in the code and has been released as AIS-052 (Revision-1) - Code of Practice for Bus Body Design and Approval. This revised Code had the formal vetting of the CMVR-Technical Standing Committee, during its 24th meeting held on July 14, 2008.

AISC and CMVR-TSC sincerely thank all the stake holders for their effective contribution in the exercise of formulation of this code and revision of the same, which was co-ordinated by ARAI.

**CODE OF PRACTICE FOR
BUS BODY DESIGN AND APPROVAL**

CONTENTS

Contents	Title	Page No.
--	Introduction	II
Chapter 1	Scope & Definitions	1/99
Chapter 2	General Requirements of Bus Body Design	10/99
Chapter 3	Technical & Safety Requirements	52/99
Chapter 4	Lighting & Illumination	66/99
Chapter 5	Electrical Equipment & Wiring	69/99
Chapter 6	Test Methods	72/99
Chapter 7	Type Approval & COP Procedure	84/99
Appendix-1	Body Structure and Nomenclature	89/99
Appendix-2	Extract of Notification No. GSR 221(E) dated 28 th March, 2001	90/99
Appendix-3	Major Bus Specifications / Features	91/99
Appendix-4	List of participants of the Sub-committee meetings	96/99
Appendix-5	List of participants for the meeting to discuss Revision of AIS-052	98/99

**CODE OF PRACTICE FOR
BUS BODY DESIGN AND APPROVAL**

**CHAPTER: 1
SCOPE & DEFINITIONS**

1.0 SCOPE

The provisions of this code are applicable to buses with a seating capacity of 13 passengers or above excluding driver.

The requirements of this code also apply to the following vehicles except in respect of those provisions* which are not compatible with the intended use and function of these vehicles:

A. High Capacity Buses like

- i. Double Decker Bus
- ii. Articulated Bus
- iii. Double Deck Articulated Bus

B. Special Purpose Buses like-

- i. Sleeper Coach
- ii. School Bus
- iii. Tourist Bus
- iv. Prison vehicles
- v. Vehicles specially designed for the carriage of injured or sick persons (Ambulances)
- vi. Off road vehicles
- vii. Vehicle Designed for use by Police, Security and Armed Forces

* Provisions to be defined and notified separately

1.1 Definitions - For the purpose of this code :

1.1.1 **‘Vehicle/Bus’** means a four or more wheeled motor vehicle designed and constructed for the purpose of transportation of 13 passengers or above excluding driver.

1.1.1.1 **‘Articulated Vehicle/Bus’** means a vehicle which consists of two or more rigid sections which articulate relative to each other; the passenger compartments of each section is interconnected by an articulate section allowing free movement of passengers between them; the rigid sections are permanently connected and can only be separated by an operation involving facilities which are normally found in a work shop.

- 1.1.2 **‘Bus Body’** means the portion of a bus that encloses the bus’s occupant space, exclusive of the bumpers, the chassis frame any structure forward of the forward most point of the windshield mounting.
- 1.1.3 **‘Ladder Type Chassis’** means the chassis frame of the vehicle and is the main load bearing element. The general construction of ladder frame consists of side and cross members. The side and cross members are connected with special gusset sections or pressed cross member sections The junctions are riveted, bolted or welded.
- 1.1.4 **‘Monocoque Construction’** means a type of bus body structure where the body and base frame are joined together either by welding or by other methods to form an integral structure. These structural elements consist of pressed grid type of support elements and rectangular sections.
- 1.1.5 **‘Type I’** Vehicles are the medium and high capacity vehicles designed and constructed for urban and sub urban / city transport with area for standing passengers, to allow movement of passengers associated with frequent stops and the low capacity vehicles which are designed and constructed for urban and sub urban / city transport exclusively for carrying seated passengers. The low capacity vehicles in this type can carry standee passengers if they meet provisions for low capacity standee buses.
- 1.1.6 **‘Type II’** Vehicles are those designed and constructed for inter-urban/ inter-city transport without specified area for standing passengers, but can carry standing passengers over short distance in the gangway; unless otherwise prohibited by the State Transport Department.
- 1.1.7 **‘Type III’** Vehicles are those designed and constructed for long distance passenger transport, exclusively designed for comfort of seated passengers and not intended for carrying standing passengers.
- 1.1.8 **‘Type IV’** Vehicles are those designed and constructed for special purpose use such as the following :-
- (1) **‘School Bus’:** means vehicles with seating capacity of 13 passengers and above excluding driver designed and constructed specially used for transporting children to and from School.
 - (2) **‘Sleeper coach’:** means vehicles designed and constructed with additional provision/berth for passengers to sleep while travelling.
 - (3) **‘Tourist Bus’:** means vehicles designed and constructed for the purpose of transportation of passengers as tourists and may be classified in any one Type of comfort levels.
 - (4) **‘Double Deck Vehicle’:** means a vehicle where the provided spaces for passengers are arranged, at least in one part, in two superimposed levels and spaces for standing passengers are not provided in the upper deck.
- Note:** Type IV (School buses) buses can be constructed to meet specifications of mix of or any of Type I / Type II / Type III requirements such as door, window, gangway, seats, exits, etc., This shall be declared by the bus manufacturer or bus builder for type approval.

- 1.1.9 **‘Low Capacity’** Vehicles include –
- (1) Micro Bus : Seating capacity of maximum 12 passengers plus driver.
 - (2) Mini Bus : Seating capacity between 13 to 22 passengers plus driver.
- 1.1.10 **‘Medium Capacity’** Vehicles include -
- (1) Midi Bus* : Seating capacity between 23 to 34 passengers plus driver.
 - (2) Standard Bus : Seating capacity between 35 to 70 passengers plus driver.
- * Provisions of this code are not applicable to Micro Buses.
- 1.1.11 **‘High Capacity’** Vehicles are the vehicles with seating capacity more than 70 passengers plus driver and include vehicles such as Single Deck Articulated Bus, Single Deck Double Articulated Bus, Double Deck Bus, Double Deck Articulated Bus and Single Deck Tandem Axle Bus etc.
- Note :** For the purpose of defining the seating capacity, a standard 3x2 layout with a seat spacing of 686 mm and seat width of 400 mm per passenger has been considered to arrive at permissible maximum seats. The computation takes into consideration areas not available for seating passengers, such as driver compartment, engine compartment, stepwell gangway etc.)
- 1.1.12 **Non Deluxe Bus(NDX)** means bus designed for basic minimum comfort level.
- 1.1.13 **Semi Deluxe Bus(SDX)** means a bus designed for a slightly higher comfort level and with provision for ergonomically designed seats.
- 1.1.14 **Deluxe Bus(DLX)** means a bus designed for a high comfort level and individual seats and adjustable seat backs, improved ventilation and pleasing interiors.
- 1.1.15 **A.C. Deluxe Bus (ACX)** means a *Deluxe Bus* which is air conditioned.
- 1.1.15.1 Provision of Air conditioning (AC) may optionally be provided in NDX / SDX buses
- 1.1.16 **‘Door’** means a sub system of a bus body that permits boarding and alighting of passengers. Door may or may not be with panel (hinged / sliding) for closing it.
- 1.1.16.1 **‘Service Door’** means a door intended for use by passengers in the normal circumstances.
- 1.1.16.2 **‘Double Door’** means a door affording two, or the equivalent of two, access passages.
- 1.1.16.3 **‘Sliding Door’** means a door, which can be opened or closed only by sliding it along one or more rectilinear or approximately rectilinear rails.

- 1.1.16.4 **‘Power operated Service Door’** means a service door which is exclusively operated by energy other than muscular energy and the opening and closing of which is controlled by driver or jointly by driver and crew member.
- Note :** In case of Indian requirement conductor (crew member) control may be necessary to operate the doors.
- 1.1.16.5 **‘Automatically Operated Door’** means a power operated service door which can be opened by a control, operated by a passenger, after activation of the control by the driver and which will close automatically.
- 1.1.16.6 **‘Emergency Door’** means a door intended for use as an exit by passengers in an emergency only.
- 1.1.17 **‘Exit’** means a service door or emergency exit.
- 1.1.17.1 **‘Emergency Exit’** means an emergency door, emergency window or escape hatch.
- 1.1.18 **‘Window’** means an aperture in the sides of the bus to let in light and air. The window need not necessarily be glazed.
- 1.1.18.1 **‘Emergency Window’** means a window, intended for use as an exit by passengers in an emergency only.
- 1.1.18.2 **‘Double Window’** means an emergency window which, when divided into two or more parts by imaginary vertical line or (plane), exhibit two parts respectively ,each of which complies as to dimensions and access with requirement applicable to a normal emergency window.
- 1.1.19 **‘Escape Hatch’** means a roof opening intended for use as an exit by passengers in an emergency.
- 1.1.20 **‘Floor or Deck’** means that part of the body work whose upper surface supports standee passengers, the feet of seated passengers and driver, and support the seat mountings.
- 1.1.21 **‘Gangway’** means the space providing access to passengers from any seat or row of seats to another seat or to any access passage; it does not include:
- The space required to accommodate the feet of the seated passengers;
 - The space above the surface of any step or staircase; or
 - Any space which affords access to one seat or row of seats
- 1.1.22 **‘Access Passage’** means the passage through a doorway to a gangway.
- 1.1.23 **‘Passenger’** means a person other than the driver.
- 1.1.24 **‘Passenger Compartment’** means the space intended for passenger use excluding any space by fixed appliances or luggage/storage compartments.

- 1.1.25 **‘Driver Compartment’** means the space intended for the driver’s exclusive use and contains driver seat, steering wheel, controls, instruments and other devices necessary for driving or operating the vehicle.
- 1.1.26 **‘Unladen kerb Mass’** means the weight of the vehicle in running order, unoccupied and unladen but complete with fuel, coolant, lubricant, tools and spare wheel.
- 1.1.27 **‘Gross Vehicle Weight’** means technically permissible maximum weight declared by the manufacturer of the vehicle and certified by the test agency.
- 1.1.28 **‘Seat’** means a structure complete with trim, capable of accommodating one or more adult person.
- 1.1.28.1 **‘Individual seat’** means a seat designed and constructed for the accommodation of one passenger.
- 1.1.28.2 **‘Double seat’** means a seat designed and constructed for the accommodation of two passengers side by side. Two seats side by side and having no interconnection shall be regarded as two individual seats.
- 1.1.28.3 **‘Continuous seat’** means a seat designed and constructed for the accommodation of two or more passengers side by side.
- 1.1.28.4 **‘Driver seat’** means the front seat intended for the seating of the driver.
- 1.1.28.5 **‘Co-driver seat’** means the front seat, on the opposite side of the driver seat, intended for seating the co-driver / conductor / helper / cleaner.
- 1.1.28.6 **‘Passenger seat’** means the seat intended for seating passengers.
- 1.1.29 **‘Seat cushion’** means the part of the seat which is arranged almost horizontally and designed to support a seated passenger.
- 1.1.30 **‘Seat-back’** means the part of the seat that is almost vertical, designed to support the passenger’s back, shoulders and, possibly his head.
- 1.1.31 **‘Adjustment system’** means the device by which the seat or its parts can be adjusted to a position suited to the seated occupant.
- 1.1.32 **‘Displacement system’** means a device enabling the seat or one of its parts to be displaced laterally or longitudinally without a fixed intermediate position of the seat or one of its parts, to facilitate access by passengers.
- 1.1.33 **‘Locking system’** means a device ensuring that the seat and its parts are maintained in the position of use.
- 1.1.34 **‘Anchorage’** means a part of the floor or of the body of a vehicle to which a seat is fixed.
- 1.1.35 **‘Seat Frame’** means structural portion of the seat assembly. The seat frame may be constructed with springs attached to the structural frame or may support padding.
- 1.1.36 **‘Padding’** means soft and resilient material installed between the seat frame sub assembly and trim covering.

- 1.1.37 **‘Trim’** means a part of the seat assembly providing an envelope for the seat frame and the padding. also provides surface, appearance, comfort and interior styling.
- 1.1.38 **‘Attachment fittings’** means bolts or other components used to attach the seat to the vehicle.
- 1.1.39 **‘Reference plane’** means the plane passing through the points of contact of the heels of the manikin, used for the determination of the H point and the actual angle of torso for the seating position in motor vehicles.
- 1.1.40 **‘Reference height’** means the height of the top of the seat above the reference plane.
- 1.1.41 **‘Reference zone’** means the space between two vertical longitudinal planes, 400 mm apart and symmetrical with respect to the H-point, and defined by rotation from vertical to horizontal of the head-form apparatus whose dimensions from the pivotal point of the hip to the top of the head is continuously adjustable between 736 mm and 840 mm.
- 1.1.42 **‘Seat spacing’** means, the distance between the front of a seat squab and the back of the seat squab of the seat preceding it, measured horizontally at a height of 620 mm above the floor.
- 1.1.43 **‘Transverse Plane’** means a vertical plane perpendicular to the median longitudinal plane of the vehicle.
- 1.1.44 **‘Longitudinal Plane’** means a plane parallel to the median longitudinal plane of the vehicle.
- 1.1.45 **‘Head Restraint’** means a device whose purpose is to limit the rearward displacement of an adult occupant’s head in relation to his torso in order to reduce the danger of injury to the cervical vertebrae in the event of an accident.
- 1.1.45.1 **‘Integrated Head Restraint’** means a head restraint which can only be detached from the seat or the vehicle structure by the use of tools or by partial or complete removal of the seat covering meet the present definition.
- 1.1.45.2 **‘Detachable Head Restraint’** means a head restraint consisting of a component separable from the seat, designed for insertion and positive retention in the seat-back structure.
- 1.1.45.3 **‘Separate Head Restraint’** means a head restraint consisting of a component separate from the seat, designed for insertion and/or positive retention in the structure of the vehicle.
- 1.1.46 **‘H-Point’** means a pivot center of the torso and thigh on the two or three dimensional device used in defining and measuring vehicle seating accommodation.
- 1.1.46.1 **‘Design H-Point’** is located on a drawing by the H-point on the two dimensional drafting template placed in any designated seating position.

- 1.1.47 **‘R-point’** or **‘Seating Reference Point’** means the manufacturer’s design H-point which establishes the rearmost normal driving or riding position of each designated seating position as stipulated by the manufacturer and which accounts for all modes of adjustments (horizontal, vertical and tilt) that are available for the seat; has co-ordinates established with respect to the designed vehicle structure; simulates the position of the pivot centre of the human torso and thigh; and is the reference point employed to position a two-dimensional template.
- 1.1.48 **‘Torso Reference Line’** means a straight line passing through the joint between the leg and the pelvis and the theoretical joint between the neck and thorax of the manikin.
- 1.1.49 **‘Cab lamp** or **Courtesy lamp’** are lamps situated above the head of the driver lighting up the dash board area and inside of the cabin. This is meant for operation while the bus is stationary. The cab lamp shall be capable of being operated only for a momentary duration while the bus is in motion.
- 1.1.50 **‘Exit lamps’** are lamps to light up the running boards. They are to light up automatically when the doors for exit or entry are opened. In the absence of closable doors at the entry and exit point, the lights are to be permanently lit during night operations of the bus.
- 1.1.51 **‘Locker lamps’** are lamps to light up the inside of the locker when the door to the locker is opened, illuminating interior of the locker.
- 1.1.52 **‘Electrical distribution panel lamp’** are lamps meant to light up electrical distribution panel when the cover to the distribution centre is opened for checking and maintenance purposes.
- 1.1.53 **‘Instrument lighting’** are lights that light up individual instruments. These can be connected to a single control through a rheostat. By varying the control, the strength of the instrument lighting can be regulated by the driver while driving in the dark to avoid glare from instrument lighting.
- 1.1.54 **‘Control unit lamps’** are similar to instrument lighting. However, these lamps illuminate individual controls discreetly to assist driver for identifying the controls.
- 1.1.55 **‘Passengers area lamps’** are lamps to light up the passenger area and assist passenger in identifying objects and reading the printed matter.
- 1.1.56 **Components of Body structure (Ref. Appendix 1)**
- 1.1.56.1 **‘Cross Bearers’** are structural members mounted on the chassis frame through ‘U’ Bolts or out rigger brackets. The cross bearers transmit the body load to the chassis and also withstand the forces induced during the normal operation of the vehicle.
- 1.1.56.2 **‘Vertical pillars’** (body pillar) are structural members that support the roof structure and are connected to the cross bearers through gussets. The Vertical pillars transmit load to the cross bearers and also withstand the forces induced during the normal operation of the vehicle.

- 1.1.56.3 **'Roof Arch Members'** are structural members that connect the vertical pillars and form a body section. In the event of a rollover, the body section absorbs the impact and provides survival protection in the passenger compartment. Gussets are also provided to improve the rigidity and strength of the body section.
- 1.1.56.4 **'Cant rails'** are structural members that connect two body sections above the window section.
- 1.1.56.5 **'Waist Rails'** are structural members that connect two body sections below the window section.
- 1.1.56.6 **'Sole Bars'** are structural members that connect two body sections at the floor plane.
- 1.1.56.7 **'Seat Rails'** are structural members running along the lateral walls and provide support for seat mounting.
- 1.1.56.8 **'Floor Runners'** are structural members that connect cross bearers.
- 1.1.56.9 **'Roof Runners'** structural members that connect roof arch members.
- 1.1.56.10 **'Out- Rigger Brackets'** are attachments that provide connection between the cross bearers and the chassis frame.
- 1.1.56.11 **'“U” Bolts'** are fasteners used for fastening the cross bearers to the chassis frame.
- 1.1.56.12 **'A Pillar'** means any roof support forward of seating reference point.
- 1.1.56.13 **Front Outrigger Members** are provided to transfer load of Body structure members. These are fixed to the chassis side members . “A” pillars are supported on outrigger members such that the roof load is transferred to the chassis load bearing members. Further in the event of a collision the energy is absorbed by the pillars and the out riggers and minimise the impact energy transmitted to the driver and passenger compartment.(Protection against frontal collision)
- 1.1.57 **'Bituminous Coating'** means Coal tar or asphalt based coating.
- 1.1.58 **'Chromated Parts'** mean parts treated with chromic acid to improve their corrosion resistance.
- 1.1.59 **'Conversion coating'** means an adherent reaction product layer on a metal surface with a suitable chemical; such as an iron phosphate.
- 1.1.60 **'Corrosion means'** the deterioration of a material, usually a metal, because of a reaction with its environment.
- 1.1.61 **'Contact Corrosion/Bimetallic corrosion'** means galvanic corrosion between two dissimilar metals.
- 1.1.62 **'Electro-Coating'** means a method of coating a metal deploying high voltages between an anode and a cathode in an electrolyte.
- 1.1.63 **'Electrogalvanised-steel'** means steel sheet produced by continuously electroplating zinc onto the steel surface.

- 1.1.64 **'Metalising'** means a process of coating a surface with a layer of metal by spraying, vacuum deposition, dipping, plasma jet, cementation etc.
- 1.1.65 **'Organic coating'** means primarily paints applied to metallic or other substrates to provide corrosion protection and to improve aesthetic characteristics of the material.
- 1.1.66 **'Phosphate Coating'** means protective coating formed by reaction of a metallic substrate with an acid phosphate containing solution.
- The primary role of the phosphating coating is to enhance the adhesion of the primer (electro coat or others) to the metal. Phosphate coatings are typically Zn-Fe, Zn-Ni. or Zn -Ni -Mn phosphates.
- 1.1.67 **'Precoated material'** means a material that has been coated prior to the manufacture of the ware or part.
- 1.1.68 **'Pretreatment'** means a surface treatment prior to the process of interest (e.g., phosphating prior to painting).
- 1.1.69 **'Prime Coat'** means the first coat of paint applied to inhibit corrosion and /or improve adhesion of the next coat.
- 1.1.70 **'Primer'** means the paint applied as the prime coat, formulated to have good bonding and wetting characteristic, and may or may not contain inhibited pigments.
- 1.1.71 **'Rust'** means corrosion product mainly consisting of hydrated iron oxides and applied only to iron and ferrous products.
- 1.1.72 **'Rust proofing'** means application of coatings intended to prevent or greatly reduce the formation of rust on steel parts.
- 1.1.73 **'Sealers'** means product applied to joints or seams to prevent the entry of moisture or contaminants or to enhance adhesion or corrosion protection.
- 1.1.74 **"Low floor vehicle"** means a vehicle in which at least 35 per cent of the area available for standing passengers (or of its forward section in the case of articulated vehicles) forms a single area without steps, reached through at least one service door by a single step from the ground.
- 1.1.75 **"Safety sign"** means sign giving a general safety message, obtained by a combination of a colour and geometric shape and which, by the addition of a graphical symbol, gives a particular safety message.

CHAPTER : 2

GENERAL REQUIREMENTS OF BUS BODY DESIGN

2.0 CATEGORISATION OF BUSES

Keeping in view the varying requirements of applications of buses and those of commuters, all buses are categorised into four Types, namely, Type I, Type II, Type III and Type IV, as defined in Chapter 1.

Each of these types of buses is further categorised as Non-Deluxe (NDX), Semi Deluxe (SDX), Deluxe (DLX) and A. C. Deluxe (ACX), on the basis of comfort level required by different categories of commuters.

Buses are also categorised as Low Capacity, Medium Capacity and High Capacity buses to cater to the traffic demand pattern, as also the frequency of the traffic. A chart depicting the categorisation of buses is given in Annexure I.

The dimensional requirements for various types / categories of buses are detailed in the following paragraphs. The corresponding technical requirements are given in Chapter 3 of this Code.

2.1 Overall Dimensions

2.1.1 Overall dimensions of the bus shall comply with the provisions laid down in Rule 93 of Central Motor Vehicle Rules, 1989, as amended from time to time. (The Committee's recommendation, notified by MoRT&H vide notification No. GSR 221(E), dated 28th March 2001 on dimensions of buses is enclosed as Appendix 2)

2.2 Internal Dimensions

2.2.1 Entry / Exits

2.2.1.1 Service Doors

2.2.1.1.1 The service door(s) shall be situated on the side of the vehicle that is nearer to the side of the road corresponding to the direction of traffic.

2.2.1.1.2 The minimum width of the service door shall be at least 650 mm. This dimension shall be reduced by 100 mm for single door and 200 mm for double door when the measurement is made at the level of the hand holds

2.2.1.1.3 In case of buses where minimum two service doors are required, the front door shall be positioned either ahead of the front axle or behind the front axle, but necessarily in the forward half of the vehicle.

2.2.1.1.4 A double service door shall be counted as two doors.

2.2.1.1.5 Each rigid section of an articulated bus shall be treated as a separate vehicle for the purpose of calculating the minimum number of exits to be provided.

2.2.1.1.6 **Number of Service Doors**

2.2.1.1.6.1 The minimum number of service doors or apertures shall be as follows, except in case of Mini & Midi buses which shall have at least one service door or aperture:

	NDX	SDX	DLX	ACX
Type I	2	2	1	1
Type II	1	1	1	1
Type III	N.A.	1	1	1

2.2.1.1.6.2 Minimum number of service doors for Mini and Midi buses shall be one.

2.2.1.1.6.3 In case of type I (DLX, ACX), type II and type III provision of second exit shall be optional.

2.2.1.1.7 **Minimum dimensions of Service Doors**

2.2.1.1.7.1 Minimum dimensions of service door apertures for buses other than Mini & Midi buses, shall be as follows (Ref. Fig 17)-

Category		Height Min. (mm)	Width min. (mm) (As Applicable)**		
			Front	Rear	Middle#
Type I	NDX	1800	650 mm for single door and 1200 mm for double door	650 mm for single door and 1200 mm for double door	650 mm for single door and 1200 mm for double door
	SDX				
	DLX				
	ACX				
Type II	NDX	1650			-
	SDX				-
	DLX				-
	ACX				-
Type III	SDX				-
	DLX				-
	ACX				-

** This dimension shall be reduced by 100 mm for single door and 200 mm for double door when the measurement is made at the level of the hand holds.”

Door apertures between two axles in case of rear engine buses of type I (except AC fitted buses) category.”

2.2.1.1.7.2 Minimum dimensions of service doors for the Midi and Mini buses shall be as follows –

	Midi & Mini Bus	
	Standee	Non Standee
Height (mm)*	1650	1500
Width (mm)**	650	650
* The dimension shall be reduced by 100mm for Mini buses with Gross Vehicle Weight (GVW) less than 3.5 tons.		
** This dimension shall be reduced by 100 mm for single door and 200 mm for double door when the measurement is made at the level of the hand holds.”		

2.2.2 Window

2.2.2.1 The window panes shall be of sliding type for all buses except AC fitted buses. However, in AC fitted buses the provision for adequate ventilation in case of A.C. failure shall be made.

2.2.2.2 The minimum width of the window aperture shall be 550 mm.

2.2.2.3 The minimum height of the window aperture shall be 550 mm for all buses and 450 mm for Midi and Mini buses. However, this dimension is not applicable to AC fitted buses.

2.2.2.4 In Type I NDX & SDX buses other than Midi and Mini buses, the upper edge of the window aperture shall be at least at the height of 1700 mm from the gangway floor area. In case of Type II NDX buses other than Midi and Mini buses, the upper edge of the window aperture shall be at least at the height of 1500 mm from the gangway floor area. However, the height of the upper edge of the window aperture from the gangway floor shall be at least 1500 mm in the rear saloon area for rear engine buses.

2.2.2.5 In case of Midi and Mini NDX buses, the height of the upper edge of the window aperture from the gangway floor shall be at least 1300 mm for buses with standees provision and 1150 mm for buses with no standees provision

2.2.2.6 The minimum dimensions of window aperture in case of AC fitted buses shall be as follows.

	Min. Dimensions (mm)	
	Other than Midi & Mini (AC fitted buses)	Midi & Mini (AC fitted buses)
Width	550	550
Height	700	450

- 2.2.2.7 However, these dimensions shall not be applicable to the following –
- (i) Front & Rear corner side windows.
 - (ii) Any other window which forms a part of emergency exit.
 - (iii) Fixed for the purpose of maintaining the minimum window pitch in relation to the overall vehicle dimension.
 - (iv) The window (s) above route and destination box fitted at left side near the entrance, at eye level.

2.2.3 Guard Rail

- 2.2.3.1 All buses except AC buses fitted with fixed or pasted glass shall be provided with minimum of two guard rails on the outer side. However, this requirement shall not be applicable for buses whose Gross Vehicle Weight (GVW) is less than 3.5 tons.”

Windows with sliding glass shall be fitted with guard rails. Fitment of guard rails on emergency windows is prohibited.

- 2.2.3.2 The first guard rail shall be provided at a height of 75 mm from the lower window sill.
- 2.2.3.3 The distance between two guard rails shall be 75 to 100 mm.

2.2.4 Emergency Exits

- 2.2.4.1 In case of standard buses of Type II (NDX, SDX, DLX, ACX) and Type III (SDX, DLX, ACX), at least one emergency exit in the form of emergency door shall be situated on the opposite side of the service door. Emergency door shall be situated in the second half of the bus if the service door is on the first half and vice a versa. Emergency door shall meet the dimensional requirements given in para 2.2.4.13 and the technical requirements of para 3.4.5.1.

Note: In case of standard buses of Type II (NDX, SDX, DLX, ACX), and standard Type III (SDX, DLX, ACX) buses, the fitment of emergency exit in the form of emergency door, shall become effective on and after 1st October 2015. This is in accordance with the discussions and decisions taken in the 42nd meeting of CMVR-TSC held on 22nd July 2014.

- 2.2.4.2 In case of Mini and Midi buses, the emergency exit shall be situated either on the opposite side of the service door or at the rear of the vehicle which may be in the form of emergency window.
- 2.2.4.3 In case of Midi and Mini Buses where the emergency door is provided on the opposite side of the service door, it shall meet the dimensional requirements given in para 2.2.4.13 and the technical requirements of para 3.4.5.1.
- 2.2.4.4 In case of Midi and Mini Buses where the emergency exit is provided at the rear of the vehicle, its minimum dimensions shall be 1250mm x 550mm for emergency door exit (refer Cl.2.2.4.13) or 4000 cm² for emergency window exit (refer Cl. 2.2.4.15). The emergency door width may be reduced to 300 mm in cases where intruding wheel arches so require, providing that the width of 550 mm is respected at the minimum height of 400 mm above the lowest part of the door aperture and the upper corners may be reduced with round-offs, with a radius of not more than 150 mm.

- 2.2.4.5 In case of more than one emergency exit, one of the emergency exit shall be situated in the front half of the vehicle, on the side opposite to the service door and the second emergency exit shall be either on the rear half or at the rear side of the bus.
- 2.2.4.5.1 In case emergency door is situated on opposite side of the service door, emergency door shall be located in the rear half of vehicle, where in service door is provided near the front of the bus. Whereas, in case if service door is provided near to the rear of the bus then emergency door shall be located in the front half of the vehicle. Alternatively emergency door can be provided at the center on the opposite side of the service door.
- 2.2.4.6 Windows of the vehicle may be considered as emergency exits provided they meet the minimum size given in para 2.2.4.15 and comply with technical requirements defined in para 3.4.5.2.
- 2.2.4.6.1 All the side wall windows fitted with breakable safety glass shall be designated as emergency windows. Designated emergency windows of breakable safety glass type shall be provided with breaking device properly fastened by suitable means like metallic chain, rope etc and shall be made easily identifiable with self-luminescent label or a lighting device.
- 2.2.4.6.2 For all buses with fixed windows as emergency exits, two additional breaking devices (hammers) to break open the safety glasses from outside by driver/co-driver shall be provided in the driver's cabin at a suitable location which should be easily accessible. Length of the handle of such breaking device shall be suitable to reach the centre of emergency window glass from outside.
- 2.2.4.7 Each rigid section of an articulated bus shall be considered as a separate unit and the connection between the two sections is not considered as an emergency exit.
- 2.2.4.8 A door provided in the rear face and not designated as a service door shall meet the requirements of emergency exit.
- 2.2.4.9 If the driver compartment does not provide access to the passenger compartment by means of a passageway, the following condition shall be met;
- The driver compartment shall have two exits, which shall not be on the same lateral wall; and one such exit is a window, it shall comply with the requirements set in para 2.2.4.15 and comply with the technical requirements defined in para 3.4.5.2.
 - Where seats are permitted along side the driver for passenger seat, both exits shall be doors. The driver door shall be accepted as emergency exit for the passengers and the second exit provided shall be accepted as the emergency exit for the driver, provided the driver controls, steering wheel, engine housing etc. do not constitute a serious obstruction.
- 2.2.4.10 If the driver compartment and seats adjacent to it are accessible from the main passenger compartment by means of a passage, no additional external exit mentioned in para 2.2.4.9 is required.
- 2.2.4.11 The fitment of any welded structure / frame restricting the opening of any of the emergency exit, from inside or outside the vehicle, shall not be permitted.

2.2.4.12 The minimum number of Emergency doors or Exits or apertures in case of other than Mini and Midi bus shall be as follows:

Category	NDX	SDX	DLX	ACX
Type I	2	2	2	2
Type II	2	2	2	2
Type III	-	2	2	2

2.2.4.12.1 In case the driver door is easily accessible from the passenger compartment, the driver door may be considered as an emergency door.

2.2.4.12.2 There shall be a minimum of one Emergency doors or Exits or apertures in case of a Mini & Midi Bus.

2.2.4.13 Minimum dimensions of the emergency exits shall be as below :

Category	Height (mm)	Width (mm)
Type I	1250	550
Type II	1250	550
Type III	1250	550

2.2.4.14 For the purpose of this requirement, service doors equipped with power operated system shall not be deemed as emergency exits unless they can be readily opened by hand, once the control specified in technical requirements para 3.4.4.9.1 has been actuated if necessary.

2.2.4.15 Minimum requirements of the emergency windows shall be as below :

Category	Area (cm ²)	Remark
Type I	4000	It shall be possible to inscribe in this area a 50 cm high and 70 cm wide rectangle.
Type II	4000	
Type III	4000	

2.2.4.16 Escape hatches additional to the emergency doors and windows, may be fitted in the roof for all category of vehicles.

2.2.4.16.1 Where escape hatches are provided the position shall be as specified below:

Number of Hatches	Position of the Hatches
One	Shall fall in the middle segment of the roof, when the entire roof is considered as three segments.
Two or more	Shall be separated by a distance of at least 2 m, when measured between the nearest edges of the aperture and in a line parallel with the longitudinal axis
Note : In case of buses accommodating CNG cylinders and AC units on the roof, escape hatch/s shall be positioned suitably.”	

2.2.4.16.2 Minimum requirements of the escape hatches shall be as below :

Category	Area (cm ²)	Remark
Type I	4000	It shall be possible to inscribe in this area a 50 cm high and 70 cm wide rectangle.
Type II	4000	
Type III	4000	

2.2.4.17 In case of standard Type I buses, emergency exit having aperture dimensions in accordance with clause 2.2.4.13 or 2.2.4.15 shall be provided. This emergency exit shall be openable/breakable from both inside and outside of the bus.

2.2.5 Steps

2.2.5.1 Dimensions of Steps in mm shall be as given in the table below:

Classes		I	II, III
First step from ground 'D'	Max. height (mm)	400 (1)(2)	400 (1)(2)
	Min. depth (mm)	300 */	
Other steps 'E'	Max. height (mm)	250 (3)	350 (4)
	Min. height (mm)	120	
	Min. depth (mm)	200	
Ref Fig. 1			
*/ 180 mm for vehicles having a capacity not exceeding 22 passengers.			
(1) 700 mm in the case of an emergency door. 1500 mm in the case of an emergency door in the upper deck of a double deck vehicle.			
(2) 400 mm in the case of Type I bus with solely mechanical suspension/ air suspension and 430 mm in the case of Type II and Type III vehicles with solely mechanical suspension.			
(3) 300 mm in the case of steps at a door behind the rearmost axle.			
(4) 250 mm in gangways for vehicles having a capacity not exceeding 22 passengers.			

Note:

1. At a double doorway the steps in each half of the access passage shall be treated separately.
2. E need not be the same for each step.

2.2.5.2 The height of the first step in relation to the ground shall be measured with the vehicle on level ground, unladen, the tyre pressure being as specified by the manufacturer corresponding to maximum technical mass.

2.2.5.3 The height of a step shall be measured at the centre of its width.

2.2.5.4 Where there is more than one step, each step may extend into the area of the vertical projection of the next step by 100 mm and the projection over the tread below shall leave a free surface at least 200 mm with all steps edges designed to minimise the risk of tripping and being in contrasting colour or colours. A yellow colour band of 50 mm width shall be provided on all steps to assist visually impaired people.

2.2.5.5 A rectangular template of 400 mm x 200 mm (width X depth) when placed over the step shall have a contact area of at least 95 %, In case of a double doorway each half of the door shall fulfil this requirement.

2.2.5.6 All steps shall be provided with anti skid surface (Aluminium chequered plate/ grooved vinyl sheet or any non-slip coating). The anti skid surface shall meet the requirements specified in AIS standard as and when notified.

2.2.6 Access to Service Doors

2.2.6.1 The free space extending inward into the vehicle from the side wall in which the door is mounted shall permit the passage of vertical template 20 mm thick, 400 mm wide and 700 mm in height above the floor, having a second panel 550 mm wide superimposed symmetrically above it. The height of the second panel being as prescribed for the relevant type of vehicle. (Refer Figure 2).

2.2.6.2 The height of the second panel be as specified below. (Ref. Fig. 2)

	Dimensions in mm				
	Other than Midi bus and Mini Bus			Midi bus and Mini Bus	
				Standee	Non Standee
Width of upper panel	550			550	550
Height of upper panel (A) **	Type I	1100	1100*	950/950*	700/950*
	Type II	950			
	Type III	850			
Total height of dual panel **	Type I	1800		1650	1400
	Type II	1650			
	Type III	1550			

- Alternate trapezoidal section having a height of 500mm, forming the transition between the width of the upper and the lower panel, may be used. In this case, the total height of the rectangle section and this trapezoidal section of the upper panel shall be 1100 mm for all types of vehicles other than Midi and Mini buses, and 950 mm for the Midi and Mini buses.

** These dimensions shall be reduced by 100 mm for Mini Buses whose Gross Vehicle Weight is less than 3.5 tons.

2.2.7 Floor Height

2.2.7.1 The height of the floor measured in relation to the ground shall be measured with the vehicle unladen.

2.2.7.2 For purposes of determining the floor height, at least 35% of the area available for the standing passengers (or in its forward section in the case of articulated vehicles, or in its lower deck in case of double decker vehicles) form a single area without steps reached through at least one service door.

2.2.7.3 The floor height shall be measured at any one of the service doors of the vehicle in unladen condition. (reference point to be specified by the manufacturer)

2.2.8 Gangways

2.2.8.1 The gangway for all the vehicle categories shall be designed and constructed to allow free passage of a gauging device consisting of two coaxial cylinders with an inverted truncated cone interposed between them. The minimum dimensions (in mm) of the device shall be as mentioned below: (Ref. Fig. 3)

	Other than Midi and Mini Bus			Midi and Mini Bus	
	Type I	Type II	Type III	Standee	Non Standee
Diameter of the lower cylinder (A)	450	350	300	350	300
Height of lower cylinder	900	900	900	900	900
Diameter of the upper cylinder (C)	550	550	450	550	450
Height of upper cylinder (B)	500	500	500	500	300
Overall Internal height (H)	1900	1900	1900	1750	1500

2.2.8.2 On rear engine vehicles the height of the upper cylinder may be reduced by 150 mm in any part of gangway to -

- the rear of a transverse vertical plane situated 1500 mm forward of the centre line of the rear axle, and
- the rear of a transverse plane situated at the rear edge of the rearmost service door, if there are more than one service door.
- the front of a transverse vertical plane situated at the centre line of the front axle.

2.2.8.3 On Articulated buses the gauging devices defined in para 2.2.8.1, shall be able to pass unobstructed through the articulate section. No part of the soft covering including parts of bellow, shall project into the gangway.

2.2.8.4 Folding seats allowing passengers to sit in the passage shall not be permitted. Folding seats in the passage shall be allowed in the case of Mini buses whose Gross vehicle Weight (GVW) is less than 3.5 tons.

Note : In case of differences between the specifications stated above and that of AIS-023, the specifications of AIS-023 shall be considered as final and standing.

2.2.8.5 Steps may be fitted in the gangway for access from low to high or high to low floor (excluding pedestal floor, wheel arch bays), provided -

- Height of the step is not less than 120 mm and not greater than 250 mm;
- Depth of the step is not less than 230 mm;
- Width of the step is same as the width of the gangway, at the top of the step

2.2.8.6 Gangways and access passages shall be covered/lined with an anti-slip material. The anti slip material shall meet the requirement of the relevant standard as and when notified.

2.2.8.7 The **slope of the gangway** with vehicle in the unladen condition and in the horizontal surface shall not exceed :

- 6% in case of Type I, Type II and Type III buses.
- 8% in case of zone rearward of a transverse vertical plane situated 1500 mm forward of the centre line of the rear axle, may be permitted.

2.2.9 Hand Rails and Hand Holds

2.2.9.1 Hand rails and hand holds shall meet AIS-046 requirement

2.2.9.2 They shall be designed and installed as to present no risk of injury to passengers. (There shall be no relative movement between the rail and mounting bracket)

2.2.9.3 Hand rails and hand holds section dimensions shall be such that the passengers can grasp them easily and firmly. Hand rail length shall be at least 100 mm to accommodate a hand or this requirement shall be in accordance with AIS-046, as amended from time to time.

2.2.9.4 Diameter of the section shall not be less than 20 mm and not more than 45 mm. Or this requirement for the diameter of the section shall be in accordance with AIS-046, as amended from time to time, for the specifications of hand holds.

2.2.9.5 In the case of handrails in access passage in Type II or Type III or non-standee mini buses and in case of handrails on doors and seats, a minimum sectional dimension of 15 mm shall be permitted provided that one other dimension is of at least 25 mm. The corners shall be rounded and devoid of sharp edges or this requirement shall be in accordance with AIS-046, as amended from time to time.

- 2.2.9.6 The clearance between a hand rail or a handhold and adjacent part of the vehicle body or lateral wall shall be at least 40 mm. However in case of a handrail on a door or seat a minimum clearance of 35 mm shall be permitted. The lateral clearance shall be 150 mm minimum or this requirement shall be in accordance with AIS-046, as amended from time to time.
- 2.2.9.7 Handrails and /or handholds shall be provided with sufficient number for each point of the floor Area intended, for the standing passengers. This requirement shall be deemed to be full filled if at least two handrails and/ or handholds can be reached is inside the envelope inscribed by the moving arm of the testing device. The dimensions of the testing device are appended in Fig. 4. The testing device is designed to rotate freely about its vertical axis.
- 2.2.9.8 Hand-rails and handholds above 800 mm and not greater than 1900 mm shall be considered to meet the above requirement.
- 2.2.9.9 For every position that can be occupied by a standing passenger, at least one of the two required Handrails or handholds shall not be more than 1500 mm above the level of the floor at that position.
- 2.2.9.10 Areas which are occupied by the standing passengers and are not separated by seats from the side walls or rear wall of the vehicle shall be provided with at least two horizontal handrails parallel to the walls and installed at a height between 800 mm and 1500 mm above the floor. The dimensions of the rail shall be as per para 2.2.9.4.
- 2.2.9.11 **Hand Rails and Hand Holds for Service Doors**
- 2.2.9.11.1 Door apertures shall be fitted with Hand Rails and/or Hand Holds on each side.
- 2.2.9.11.2 Handrails and Handholds provided for service doors shall be such that they include a grasping point available to a person standing on the ground and adjacent to the service door or any of the successive door steps. Such point shall be situated, vertically, between 800 to 1000mm above the ground or from the surface of each step, and horizontally,
- a) For position appropriate to the person standing on the ground, not more than 400 mm inwards from the outer edge of the first step, and
 - b) For position appropriate to the particular step not more than 400 mm inward from the inboard edge of that step and not outwards from the outer edge of the step considered.
- 2.2.9.11.3 In case of a double door in the vehicle, no centre stanchion or hand rail shall be fitted for ultra-low floor buses.

2.2.10 Guarding of Stepwells

Where a seated passenger is likely to be thrown into a stepwell as a result of heavy braking, a guard shall be provided. The guard height shall be minimum 800 mm from the floor, and the guard shall extend inward from the wall at least 100 mm more than the centre line of the seating position of the passenger who is prone to this risk or upto the edge of the riser of the innermost step, which ever is higher in dimension.

2.2.11 Seats

2.2.11.1 All the seats shall be installed facing forward, except in case of Type I buses

2.2.11.2 Seat Layout

Seat Layout	Other than Mini & Midi Bus											Mini & Midi bus
	Type I				Type II				Type III			
	NDX	SDX	DLX	ACX	NDX	SDX	DLX	ACX	SDX	DLX	ACX	
2X1												✓*
2X2	✓	✓	✓	✓			✓	✓		✓	✓	✓
3X2					✓	✓			✓			

* In Midi & Mini buses, where it is not possible to meet the gangway requirements with 2X2 seat layout, the 2X1 seat layout may be provided.

- Note :** (i) In case of 2x1 and 3x2 seat layout, the rows with lower number of seats shall be on service door side.
- (ii) Seat layouts other than mentioned in aforesaid Table shall also be permitted provided that they meet AIS-023 requirements

2.2.11.3 Driver Seat / Co-Driver Seat

Driver / Co-driver Seat shall comply with the requirements specified in AIS-023 – “Automotive Vehicles – Seats, their Anchorages & Head Restraints”, as amended from time to time.

2.2.11.4 Passenger Seats :

2.2.11.4.1 **‘Seat Width’** The minimum width of a seat cushion, measured from the vertical plane passing through the center of that seating position shall be as per AIS-023, as amended from time to time except school bus. For school bus it should be as per AIS-063.

Ref. Fig. 5

Width of seat Cushion on each side In mm (F)	Type I & II				Type III		
	NDX	SDX	DLX	ACX	SDX	DLX	ACX
	200	200	200	200	225	225	225

For vehicles 2.35 m in width or less, the minimum seat width (F) shall be 200 mm. For vehicles above 2.35 m and up to 2.6 m in width, with 3X2 seating layout, the minimum seat width (F) shall be 200mm.

2.2.11.4.2 **The minimum width of available space for each seating position (G):**

The minimum width of the available space for each seating position (G), measured from a vertical plane passing through the centre of that seating position between heights of 270 and 650 mm above the uncompressed seat cushion, shall be:

- 250 mm in the case of individual seats, and
- 225 mm in the case of continuous seats for two or more passengers.

Ref. Fig 5

For vehicles 2.35 m in width or less, the width of the available space for each seating position shall be 200 mm. Ref Fig. 5

For vehicles having a capacity not exceeding 22 passengers, in the case of seats adjacent to the wall of the vehicle, the available space does not include, in its upper part, a triangular area 20 mm wide by 100 mm high. In addition, the space needed for safety belts and their anchorages and for the sun visor should be considered as exempted.

For vehicles above 2.35 m and up to 2.6 m in width, with 3X2 seating layout, the minimum width of available space for each seating position (G) shall be 200mm.

2.2.11.4.3 **The minimum backrest height (H):**

This is expressed as the vertical distance between the floor and the top of the seat or headrest. The dimension shall be as per AIS-023, as amended from time to time. Ref. Fig 5, Dimension H.

Type I	800 mm
Type II	1000 mm
Type III	1100 mm

2.2.11.4.4 Minimum armrest height from cushion (if provided): 175 mm. Ref. Fig 5

2.2.11.4.5 **Armrest width (if provided):**

The minimum Armrest width, wherever provided shall be as follows.

- Type I and Type –II : 40 mm.
- Type – III : 50 mm

The Armrest could be either fixed or retractable.

Ref. Fig 5

2.2.11.4.6 Depth of seat cushion :

The minimum depth of seat cushion shall be as follows (Ref. Fig. 6)

	Type I				Type II & III		
Depth of seat cushion in mm	NDX	SDX	DLX	ACX	SDX	DLX	ACX
	350	350	350	350	400	400	400

Note : In case of differences between the values specified above and that of AIS-023, the values specified in AIS-023 shall be considered as final and standing.

2.2.11.4.7 Seat Spacing :

2.2.11.4.7.1 The distance between the front of a seat squab and the back of a seat squab of the seat preceding it, shall when measured horizontally and at a height 620 mm from the floor shall not be less than following (in mm) :(Ref. Fig. 7)

	NDX	SDX	DLX	ACX
Type I	650	650	650	650
Type II	680	680	680	680
Type III	-	680	680	680

Note : In case of differences between the values specified above and that of AIS-023, the values specified in AIS-023 shall be considered as final and standing.

2.2.11.4.7.2 All measurements shall be taken, with the seat cushion and squab uncompressed in the vertical plane passing through the centerline of the individual seating space. (Ref. Fig. 7)

2.2.11.4.7.3 Reclining passenger seats shall be measured with the seat back in the normal position as specified by the manufacturer.

2.2.11.4.7.4 In case rearward clearance is provided, it shall continue upwards above the 100 mm level as an inclined plane and intersect the front edge of the seat structure immediately below the cushion.

2.2.11.4.7.5 For seat facing one another the minimum distance between the front faces of the seat squab of the facing seats, as measured across the highest points of the seat cushion shall not be less than 1300 mm.

2.2.11.4.8 **Seat base height (T) (Ref. Fig. 7)**

The height of the uncompressed seat cushion (T) i.e. the distance from the floor to the horizontal plane tangent to the front upper surface of the seat cushion shall be between 450 ± 50 mm. This height may however be reduced to not less than 350 mm at the wheel arches and engine compartment.

2.2.11.4.9 **Minimum torso angle (\square)(Ref. Fig. 8)**

NDX : 12°

SDX, DLX and ACX : 15°

DLX and ACX buses shall have adjustable reclining seats.

2.2.11.4.10 **Seat Base:-Thickness**

The thickness of seat base in mm may be as follows: (Ref. Fig. 9)

	Type I & II				Type III		
	NDX	SDX	DLX	ACX	SDX	DLX	ACX
Thickness of seat cushion Front edge (min)	90	110	130	130	110	130	130
Thickness of seat cushion Rear edge (min)	60	80	100	100	80	100	100

Note : In case buses are fitted with PPLD/LDPE seats, the seat cushion thickness shall be minimum 25 mm.

2.2.11.4.11 **Seat Back:- Thickness**

The thickness of seat cushion back in mm may be as follows :(Ref. Fig. 9.)

	NDX	SDX	DLX	ACX
Type I	25	25	50	50
Type II	25	50	75	75
Type III	-	50	75	75

Note : In case buses are fitted with PPLD/LDPE seats, the seat back rest thickness shall be minimum 10 mm.

2.2.11.4.12 **Clearance Leg Space for seated passengers:**

A minimum clear space in front of each passenger seat shall be provided as shown in Fig. 10. The seat back of another preceding seat or a partition whose contour correspond approximately to that of the inclined seat back may intrude into this space as provided by Para 2.2.11.4.7. The local presence of seat legs in this space shall also be permitted provided that adequate space remains for the passenger's feet. In the case of seats alongside the driver's seat in vehicle with up to 22 passengers, intrusion of the dashboard, instrument panel, windscreen, sun visor, seat belts and seat belt anchorages shall be allowed.

Note : In case of differences between the specifications mentioned above and that of AIS-023, the specifications given in AIS-023 shall be considered as final and standing.

2.2.11.4.13 **Free height and Intrusion over seating position:**

2.2.11.4.13.1 **Free height over seating position (Head Room) (Ref. Fig. 11):**

Each seating position shall have free height of not less than 900 mm measured from the highest point of the uncompressed seat cushion. This free height shall extend over the vertical projection of the whole area of the seat and the associated foot space. However in the case of Mini Buses with Gross Vehicle weight (GVW) less than 3.5 tons, the free height shall not be less than 800 mm.

Note : In case of differences between the specifications mentioned above and that of AIS-023, the specifications given in AIS-023 shall be considered as final and standing.

2.2.11.4.13.2 **Intrusion over seating position (Ref. Fig. 11):**

In the space extending above the area mentioned in para 2.2.11.4.13.1, the following intrusions shall be permitted:

- Intrusion of the back of another seat;
- Intrusion of a structural member provided that the intrusion is

included within a triangle whose peak is situated 650 mm from the floor and whose base is 100 mm in width and situated in the upper part of the space in question, adjacent to the side wall of the vehicle

2.2.11.4.13.3 **Intrusion of Wheel arches (Ref. Fig. 11A & 11B):**

Wheel arch intrusion shall be permitted in the case of Mini buses whose Gross Vehicle Weight (GVW) is less than 3.5 tons. However, in the case of a vehicle for upto 22 passengers excluding mini buses whose Gross Vehicle Weight (GVW) is less than 3.5 tons, intrusion of wheel arch shall be permitted, provided that one of the following two conditions is fulfilled.

2.2.11.4.13.3.1 The intrusion does not extend beyond the median vertical plane of the seating position. Ref. Fig. 11A

2.2.11.4.13.3.2 The nearest edge of the area 300 mm in depth available for the feet of the seated passenger is advance no more than 200 mm from the edge of the uncompressed seat cushion and to not more than 600 mm in front of the squab of the seat , these measurements being made in the median vertical plane of the seating position. Ref. Fig. 11B. In the case of two seats facing each other this provision shall apply to only one of the seats and the remaining space for the feet of seated passengers must be at least 400 mm.

Note : In case of differences between the specifications stated above and that of AIS-023, the specifications of AIS-023 shall be considered as final and standing.

2.2.11.4.13.4 In the case of seats alongside the driver’s seat in vehicles with up to 22 passengers, intrusion of hopper type windows when open and their fittings, of the dashboard / instrument panel, windscreen, sun visors, seat belts, seat belt anchorages and front dome.

2.2.12 Cabin Luggage Rack

2.2.12.1 All buses except Type I and Mini buses shall have cabin luggage racks. The Cabin Luggage Rack shall be optional in the Type I & Mini buses. The minimum dimensions of the cabin luggage rack shall be as given below.

	Type I	Type II and Type III	
		Mini and Midi	Other than Mini and Midi
Width from Side wall (in mm)	250	250	350
Height from Roof (in mm)	200	200	250

2.2.12.2 The cabin luggage racks shall be designed in such away that the luggage is prevented from falling in the event of sudden braking or due to forces generated during cornering.

2.2.13 Luggage hold areas/compartments

2.2.13.1 No Roof luggage carriers shall be provided on any type of bus.

2.2.13.2 Luggage hold areas/compartments shall be provided on Type III buses. This requirement shall be optional for other categories of buses.

2.2.13.3 Luggage holds areas/compartments shall be provided at the rear or at the sides, or both, with sufficient space and size, and shall be rattle proof, dust proof with safety arrangements.

2.2.13.4 Minimum luggage capacity (inclusive of cabin luggage rack capacity) shall be 25 litres (0.025 m3) per seated passenger.

- 2.2.13.5 Luggage capacity for following special vehicles of Type III with length > 10 m & width > 2.4 m shall be as specified against each:
- ✓ Articulated Buses: No of seated passengers in both coaches x 25 litres (0.025 m3)
 - ✓ Sleeper Coaches: (No of seated passengers + No of berthed passengers) x 25 litres (0.025 m3)
 - ✓ Double Deckers: No of seated passengers in both decks x 8 litres (0.008 m3)

2.2.13.6 For Drive-Away Chassis vehicle, OEM shall demonstrate on relevant drawings the feasibility of the luggage capacity. These details shall also be included in the user’s manual for guiding the bus body builder.

Note: Provision of Luggage hold areas / compartments shall be implemented along with AIS 052 Phase II implementation.

2.2.14 Reserved

2.2.15 Destination Board for Public Service Vehicles

2.2.15.1 Minimum of three destination boards shall be provided in Type I buses with at least one destination board each on front, rear and the service door side of the bus. However, in the case of Mini buses with Gross Vehicle Weight (GVW) less than 3.5 tons, at least two destination boards shall be provided.

2.2.15.2 For Type II and Type III minimum two destination boards shall be provided with one in the front and on in the rear.

2.2.15.3 The minimum dimensions of the destination board shall be as given below

Location	Height	Width		Mini and Midi buses	
		Type I	Type II & Type III	Height	Width
Front	220	1800	900	200	800
Rear	220	900	900	200	800
Service Door Side	220	900	900	200	800

Note: The destination boards should be located in such a manner that they do not hit the heads of passengers while moving or while sitting. Also the front destination board should not hamper the driver’s vision. If the rear wind screen is declared as emergency exit then the rear destination board should not hinder with the required area of emergency exit. Preferably, the destination boards should be accommodated in the structure of the bus so that no part of the destination board protrudes out and becomes a concern for passenger’s safety.

- 2.2.15.4 The destination board shall be illuminated such that the whole of the destination board and the writing thereon are legible at a minimum distance of 30 metres.
- 2.2.15.5 Provision of Destination board can be made optional, for school buses, staff buses and buses, other than public transport buses irrespective of type I, II, III and IV.
- 2.2.16 Driver's Work Area**
- Buses other than Midi and Mini Buses shall meet following driver work area requirements:
- 2.2.16.1 **Driver Entry and Exit**
- 2.2.16.1.1 **Driver Door (including Mini and Midi Buses)**
- 2.2.16.1.1.1 All buses shall be provided with a driver door.
- 2.2.16.1.1.2 Reserved
- 2.2.16.1.1.3 The minimum height of the driver door aperture, i.e., clear opening excluding handles, measured from the bus floor in the driver's area, shall not be less than 1250 mm high and 650 mm wide. In case of Midi and Mini buses, this dimension shall be 1050 mm high and 650 mm wide.
- 2.2.16.2 **Climb Facility**
- 2.2.16.2.1 The maximum height of first step from the ground shall be 550 mm.
- 2.2.16.2.2 The maximum height of other steps shall be 350 mm.
- 2.2.16.2.3 The maximum number of steps shall be four.
- 2.2.16.2.4 The minimum step width shall be 150 mm.
- 2.2.16.2.5 Minimum step depth shall be 150 mm.
- 2.2.16.2.6 The steps need be provided with anti-slip surface. The anti-slip surface shall comply with the relevant AIS standard as and when notified.
- Note:** The driver should be able to ergonomically use all the steps for climbing into the driver's cabin.
- 2.2.16.2.7 Dimensions specified in clauses 2.2.16.2.2. to 2.2.16.2.6 shall be made applicable in case of emergency exit steps.
- 2.2.16.3 **Hand Holds**
- 2.2.16.3.1 Driver door hand holds shall meet AIS-046 requirement
- 2.2.16.4 **Dimensional Requirement**
- 2.2.16.4.1 **Reference System for dimensions** - The intersection point (co-ordinate origin) of all the three planes corresponds to the vehicle projected at the heel point of the accelerator pedal. (Refer Fig. 13)

- 2.2.16.4.2 **Heel Point** - Heel point shall be located at a minimum distance of 340 mm from the inner face of the bulkhead. For this purpose the bulkhead is defined as a structure ahead of the heel point, supporting the front structure of the vehicle.
- 2.2.16.4.3 **Reference Point** - The “H” Point (Reference Point) shall be specified by the Chassis Manufacturer.
- 2.2.16.4.4 **Work area Dimension –**
- 2.2.16.4.4.1 The minimum width of the driver area from the right side wall shall be 800 mm, at a height of 900 mm from the heel point horizontal plane.
- 2.2.16.4.4.2 The minimum distance of driver partition from the driver seat shall be 25 mm from the rearmost point of the driver seat in its rearmost position with seat back reclined backwards to an angle of 12 degrees. (Refer dimension F in Fig. 14)
- 2.2.16.4.4.3 The minimum distance from H-point to roof top shall be 1060 mm. (Refer dimension D in Fig. 14)
- 2.2.16.4.4.4 The distance between the heel point and the H – point shall be between 600 mm to 640 mm. (Refer dimension A in Fig. 14)
- 2.2.16.4.4.6 The distance of H-point from floor shall be minimum 500 mm with the driver seat in the upper most position. (Refer dimension B in Fig. 14)
- 2.2.16.4.5 **Position of Steering Wheel**
- 2.2.16.4.5.1 The chassis manufacturer shall specify the position of the steering wheel with reference to the heel point.
- 2.2.16.4.5.2 The minimum distance of lower end of steering wheel from driver seat back shall be 350mm. (Refer dimension E in Fig. 14)
- 2.2.16.4.5.3 The thigh clearance of the steering wheel with driver seat in the upper most position shall be between 200 mm to 260 mm. (Refer dimension C in Fig. 14)
- Note:** Manufacturer may submit a drawing highlighting all dimensional requirements of this clause to Test Agency, for compliance to 2.2.16.4.
- 2.2.16.4.6 **Placement of Instrument Panel**
- 2.2.16.4.6.1 The placement of instrument panel shall be such that the primary instruments and controls are visible unobstructed while viewed from the driver seat. A typical driver information layout is shown in Fig. 15.
- 2.2.16.4.6.2 The dashboard shall be of non metallic, fire resistant, energy absorbing material and so constructed that in the event of a collision it shall cause minimum injury to the driver.

2.2.16.4.7 **Shroud for Wiring Harness**

2.2.16.4.7.1 A suitable non metallic, fire resistant, energy absorbing cover shall be provided for the wiring harness and other exposed parts below the instrument panel. The cover shall be so constructed that in the event of a collision it shall cause minimum injury to the driver.

2.2.16.4.8 **Position of Controls**

2.2.16.4.8.1 The position of the controls such as accelerator, clutch, gear lever, service brake, parking brake etc. shall be specified by the vehicle manufacturers.

2.2.16.4.9 **Heating, Cooling & Ventilation for Driver**

2.2.16.4.9.1 The driver's work area shall be provided with the blowers or other suitable devices to ensure proper ventilation. These devices shall be capable of minimum of three air changes per minute or as per standard whenever notified.

2.2.17 Standee Passenger Area

The capacity of standee passengers to be allowed in a bus will be governed on the basis of free bus floor area available for standee passengers (Asp) by calculating at the rate of six standee passengers per Sq. Metre. the surface area "Asp" available for standee passengers will be calculated after deducting the following from the total floor area of the vehicle :-

- I. The area of driver's compartment i.e. the space intended for driver's exclusive use and containing the driver's seat, the steering wheel, control, instruments and other devices necessary for driving or operating the vehicle.
- II. The area of steps at door and the area of any other step with a depth of less than 30 cms. and the area swept by the door and its mechanism when it is operated.
- III. The area of any part over which the vertical clearance is less than 135 cms. e.g. above wheel arch and above the engine, measured from the floor, according to the specified method and disregarding permitted intrusion.
- IV. The area of any part of the vehicle to which access to passengers to be prevented for safety or any other reasons e.g. space available on both sides of the driver.
- V. The area of floor space reserved solely for carriage of goods and luggage and from which passengers are excluded.
- VI. the floor area occupied by any staircase in the vehicle
- VII. The area of all parts which are not accessible to a standee passenger.
- VIII. The area 30cms. in front of any seat.

- IX. The area of all parts where the clear height above the floor is less than 190 cms. or in the case of the section of the gangway situated above and behind the rear axle, and attaching parts thereof, less than 180 cms. (excluding the hand – holds in this case).
- X. The area forward of a vertical plane passing through the centre of the seating surface of the drivers seat (in its rear – most position) and through the centre of the exterior rear – view mirror mounted on the opposite side of the vehicle.
- XI. Any part of the surface of the floor (e.g. a corner or edge) on which it is not possible to place any part of the rectangle of 400 mm x 300 mm.
- XII. Any surface area which is not capable of circumscribing a rectangle of 400 mm x 300 mm. the vehicle.
- XIII. The bus floor space of 150mm width along the bus gangway for facilitating movement of the passengers / conductor.
- XIV. The area of all parts of the bus floor in which the slope exceeds the maximum permissible value as prescribed in clause 2.2.8.7.

2.2.18

Design Seating and Standee Passenger Capacities

2.2.18.1

The design seating capacity of a bus shall be calculated based on the seat layout and seat spacing as given in the table below.

Category	Seat Layout	Seat Width (in mm)	Seat spacing (in mm)
Type I NDX	2x2	400	650
Type I SDX	2x2	400	650
Type I DLX	2x2	400	650
Type I ACX	2x2	400	650
Type II NDX	3x2	400	680
Type II SDX	3x2	400	680
Type II DLX	2x2	400	680
Type II ACX	2x2	400	680
Type III SDX	3x2	450	680
Type III DLX	2x2	450 or 500 (individual seat)	680
Type III ACX	2x2	450 or 500 (individual seat)	680

Note :

- (1) The seat layout could be at the option of the bus builder , subject to the maximum seat layout specified in the table above and accordingly the seating area may be computed based on the above table information.
- (2) In case of Mini & Midi bus where it is not possible to meet gangway requirement with 2x2 seat layout, 2x1 seat layout may be used for the purpose of calculating the seating capacity.
- (3) In case of differences between the values specified above that of AIS-023, the specifications of AIS-023 shall be considered as final and standing.

2.2.18.2 The minimum gangway width for the calculation shall be as given in para 2.2.8.1.

2.2.18.3 The seating and standee passenger capacities shall be indicated in the Type Approval certificate for the bus body design.

2.2.18.4 Formula for calculation of seating and standee passenger areas –

Dimension	Description	Area (in mm²)
Area of the Driver Compartment	Width x Depth of Driver Work Area	Ad
Total projected Step Well Area (all stepwells)	Sum of projected Area of all Step Wells	As
Projected area of Engine	Width x Length of Engine projected on the floor Area	Ae
Area of any part of the Vehicle where vertical clearance is less than 1350 mm (Engine etc.)	-	Aw
Area required to provide a clear work area at service floor area occupied by any stair case	-	Ast
Area of parts where clear height above floor level less than 1900 mm (1750mm in case of mini bus)	-	Ac
Area of seat in facing partition	(300 mm x Total seat width)	Ap
Area of the parts where slope exceeds the maximum specified value for purpose of passengers	-	Asl

Total Area excluded for purpose of calculating seated passenger capacity	Sum (Ad+As+Ae+Aw+Ag+Ast+Ap)	Aex
Area of Gangway	-	Ag
Total internal Floor Area	Internal Width x Internal Length	Aint
Area for seated Passengers	Aint-Aex	Apass
Area for standee passengers	Ag – (Ac + Asl + 150mm x Length of Gangway)	Astd

Note : Value of Astd is the solution of following three equations –

$$Aex = Ad + As + Ae + Aw + Asl + Ag + Ast + Ap$$

$$Apass = Aint - (Aex + Ag)$$

$$Astd = Aint - (Ad + As + Ae + Aw + Ast + Ac + Ap + Asl + Apass + 150mm \times \text{Length of Gangway})$$

2.2.18.5

Formula for calculation of number of seats and number of standees permitted.

Seating Capacity

a	No. of Seats accommodated with respect to space available in bus	$A_{pass} / (\text{seat Spacing} \times \text{seat width})$
b	No. of seats accommodated with respect to payload*	
c	Seating Capacity (Lowest of a and b)	

Standee Capacity

a1	No. of Standee accommodated with respect to space available in bus	$A_{std} \times 6 \times 10^{-6}$
b1	No. of standee accommodated with respect to payload ((Payload/75) – c)	
c1	Standee Capacity (lowest of a1 and b1)	
*Pay load for single passenger shall be 75 Kg (68 Kg Person’s weight+ 7Kg Weight).		

2.2.19

Provisions for Differently Abled Passengers

2.2.19.1

All Type I buses shall have at least two passenger seats in case of Mini & Midi buses and four passenger seats in case of other buses designated as priority seats for persons with disabilities. These seats shall be only of the forward facing type and preferably be located behind the driver’s seat.

- 2.2.19.2 The seats designated for Differently Abled Passengers shall be indicated with appropriate sign(s). An illustration of the signs to be provided above the priority seats is shown in Figure 16.
- 2.2.19.3 The priority seats shall be provided with appropriate facility for securing the crutches, canes, walkers etc. to facilitate convenient travel for persons with disabilities.
- 2.2.19.4 Handrails and / or stanchions shall be provided at the entrance of all Type I buses in a configuration, which allows persons with disabilities to grasp such assists from outside the vehicle while starting to board, and to continue using such assists throughout the boarding process, until they reach the designated seating area. The dimensions of the hand rails shall be as per para 2.2.9.
- 2.2.19.5 All Type I NDX buses shall be provided with controls adjacent to priority seats for requesting stops and which alerts the driver that a mobility aid user wishes to disembark. Such a system shall provide auditory and visual indications that the request has been made. Controls shall be mounted not higher than 1300 mm and now lower than 410 mm above the floor, shall be operable with one hand and shall not require tight grasping, pinching, or twisting of the wrist. The force required to activate controls shall not be greater than 2.2 kg.
- 2.2.20 Side Underrun Protection**
- 2.2.20.1 The requirements of Side under run protection shall be in accordance with IS-14682:2004, as amended from time.
- 2.2.21 Rear Underrun Protection**
- 2.2.21.1 The requirements of Rear Under run Protection shall be in accordance with IS-14812:2005, as amended from time to time.
- 2.2.22 Provision of Toilet**
- 2.2.22.1 In case of Type III ACX buses a toilet may be provided.
- Note :** The requirements for various categories of buses are also provided in matrix form in Appendix 3.
- 2.2.23 External Projections:**
- 2.2.23.1 The requirements of external projections shall be in accordance with IS: 13942 - 1994, as amended from time to time and as notified under Rule 124 of the Central Motor Vehicles Rules, 1989.
- 2.2.24 Interior Fittings:**
- 2.2.24.1 The requirements of interior fittings shall be in accordance with AIS-047, as amended from time to time and as notified under Rule 124 of the Central Motor Vehicles Rules, 1989.

2.2.25 Public Information System

2.2.25.1 All Type I, Type II and Type III public service buses shall be provided with Audio / Visual or Audio-Visual Information System permitting driver or recorded or digitized human speech / visual messages, to inform passengers inside the bus regarding emergency escape provisions, destination, bus stops etc. This arrangement will enhance passenger safety.

2.2.25.2 All Type I, Type II and Type III public service buses shall be provided with a emergency declaration switch to be operated by the driver / co-driver. This switch should activate a Audio hooter and Visual red blinking light inside and amber light outside the bus to declare an emergency for speedy evacuation of the passengers.

ANNEXURE 1
(See 2.0)

Categorisation of Buses

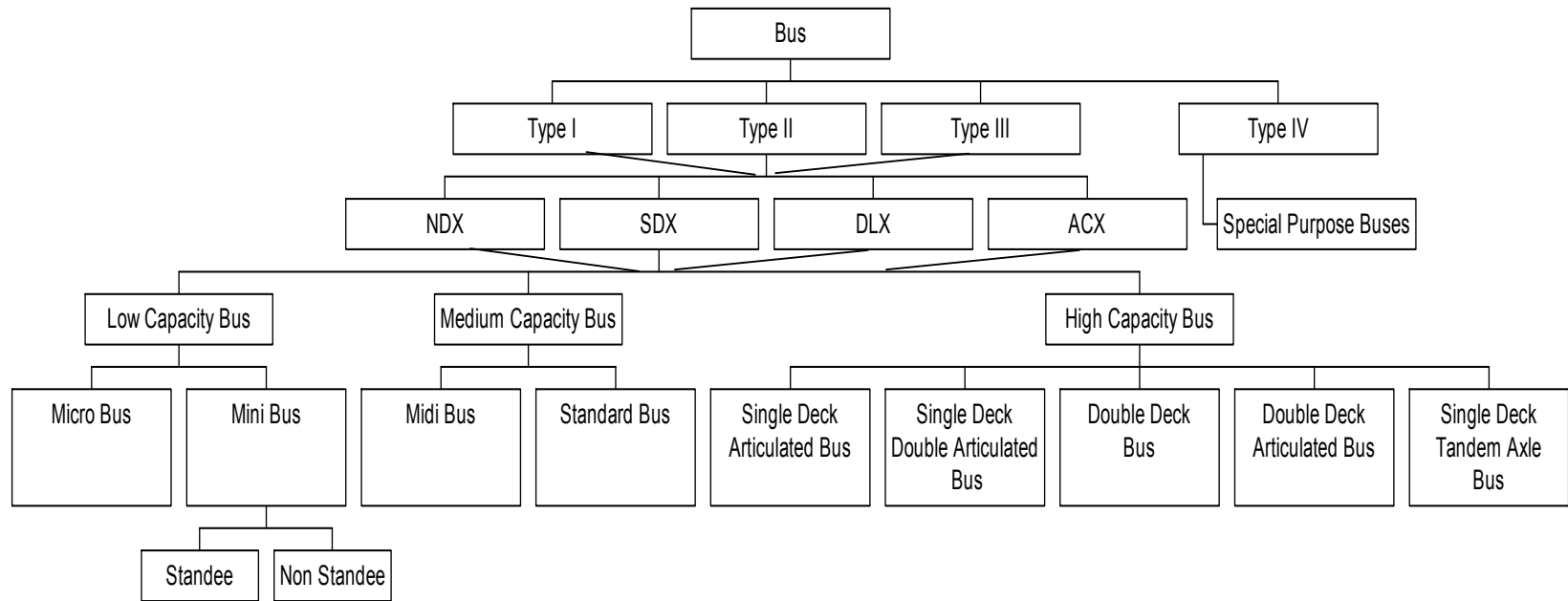

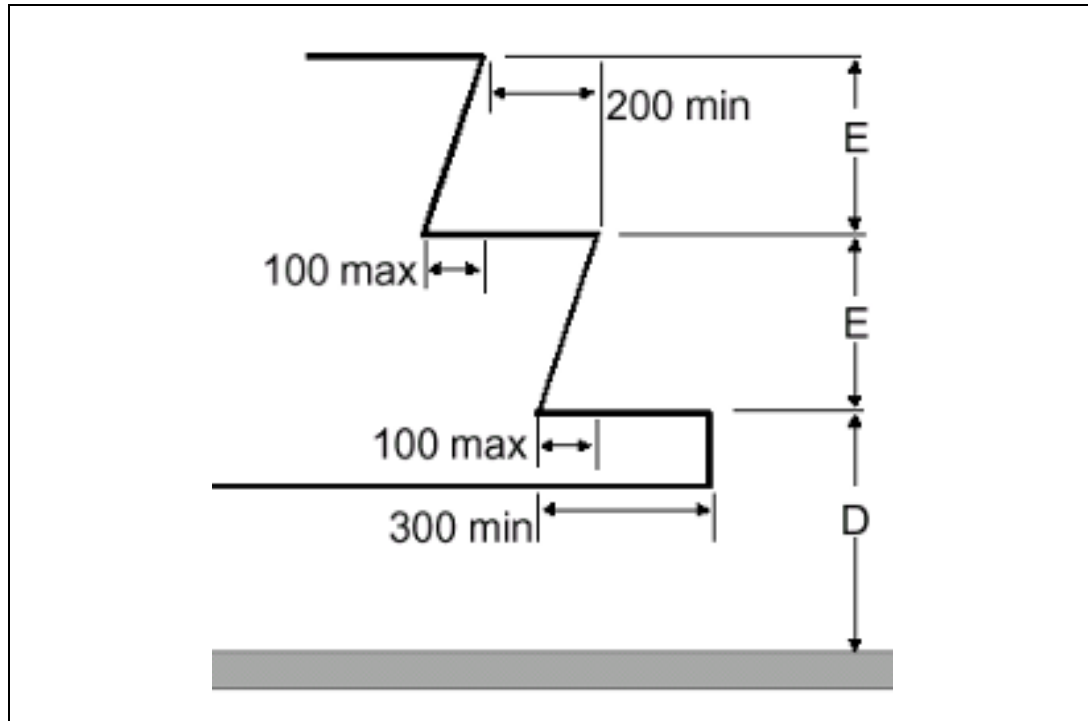

Figure 1
Steps

Classes		I	II, III
First step from ground 'D'	Max. height (mm)	340 (1)(2)	380 (1)(2)(5)
	Min. depth (mm)	300 */	
Other steps 'E'	Max. height (mm)	250 (3)	Other steps 'E'
	Min. height (mm)	120	
	Min. depth (mm)	200	
		*/ 180 mm for vehicles having a capacity not exceeding 22 passengers.	
		(1) 700 mm in the case of an emergency door. 1500 mm in the case of an emergency door in the upper deck of a double deck vehicle.	
		(2) 400 mm in the case of Type I bus with solely mechanical suspension and 430 mm in the case of Type II and Type III vehicles with solely mechanical suspension	
		(3) 300 mm in the case of steps at a door behind the rearmost axle.	
		(4) 250 mm in gangways for vehicles having a capacity not exceeding 22 passengers.	
		(5) For at least one service door; 400 mm for other service doors.	
		Note: 1. At a double doorway the steps in each half of the access passage shall be treated separately.	
		2. E need not be the same for each step.	

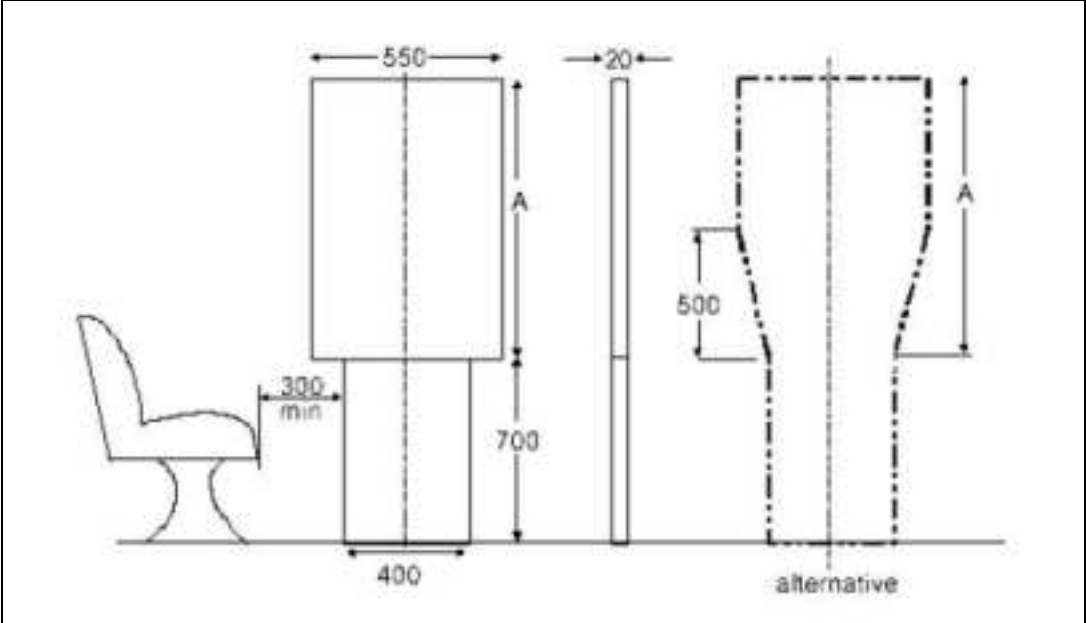

Figure 2
Access to Service Doors

	Dimensions in mm			
	Other than Midi and Mini Bus		Midi and Mini bus	
			Standee	Standee
Width of upper panel	550		550	550
Height of upper panel (A)	Type I	1100	1100*	950/950*
	Type II	950		
	Type III	850		
Total height of dual panel	Type I	1800	1650	1400
	Type II	1650		
	Type III	1550		

* Alternate trapezoidal section having a height of 500mm, forming the transition between the width of the upper and the lower panel, may be used. In this case, the total height of the rectangle section and this trapezoidal section of the upper panel shall be 1100 mm for all types of vehicles other than Midi and Mini buses, and 950 mm for Midi and Mini buses.

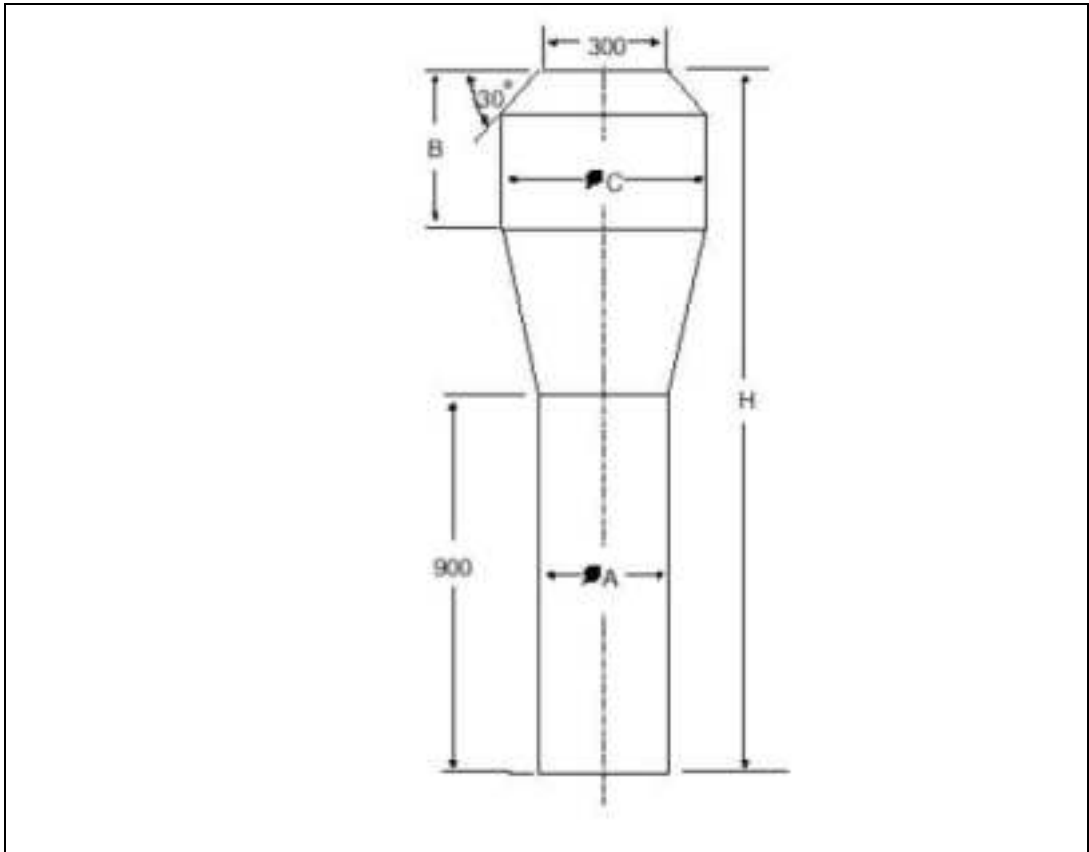

Figure 3
Gangways

	Other than Midi and Mini Bus			Midi and Mini Bus	
	Type I	Type II	Type III	Standee	Non Standee
Diameter of the lower cylinder(A)	450	350	300	350	300
Height of lower cylinder	900	900	900	900	900
Diameter of the upper cylinder(C)	550	550	450	550	450
Height of upper cylinder(B)	500	500	500	500	300
Overall Internal height(H)	1900	1900	1900	1750	1500

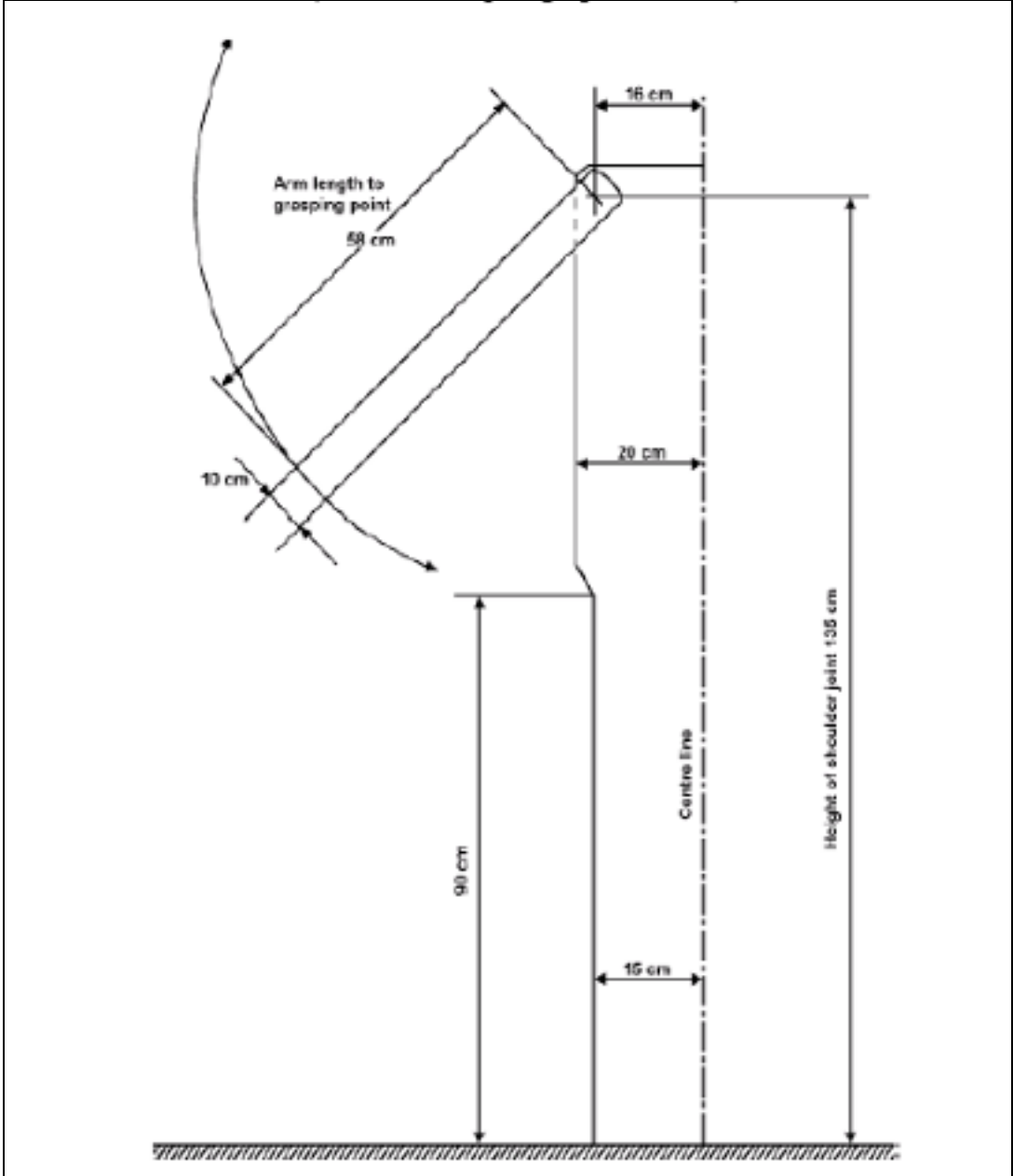

Figure 4
Siting of Hand Holds – Testing of Hand Holds

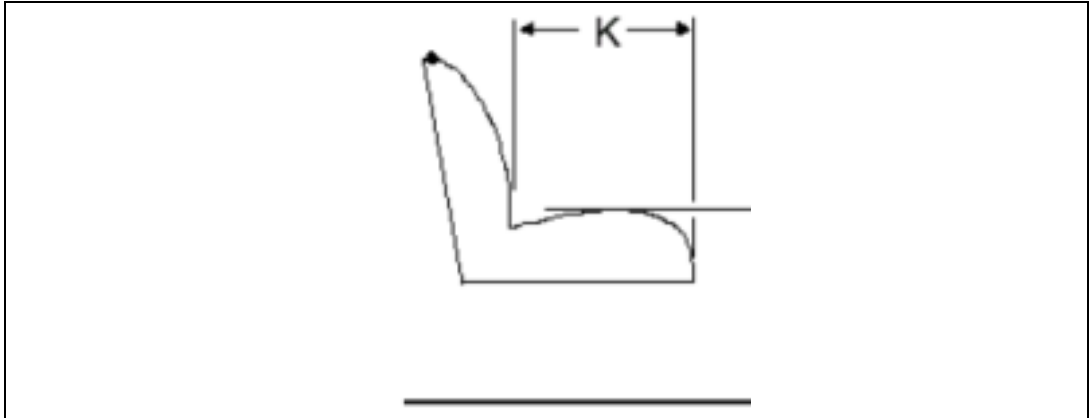

Figure 6
Depth of Seat Cushion

The minimum depth of seat cushion shall be as follows:

Depth of seat cushion,(K) in mm	Type I				Type II & III		
	NDX	SDX	DLX	ACX	SDX	DLX	ACX
	350	350	350	350	400	400	400

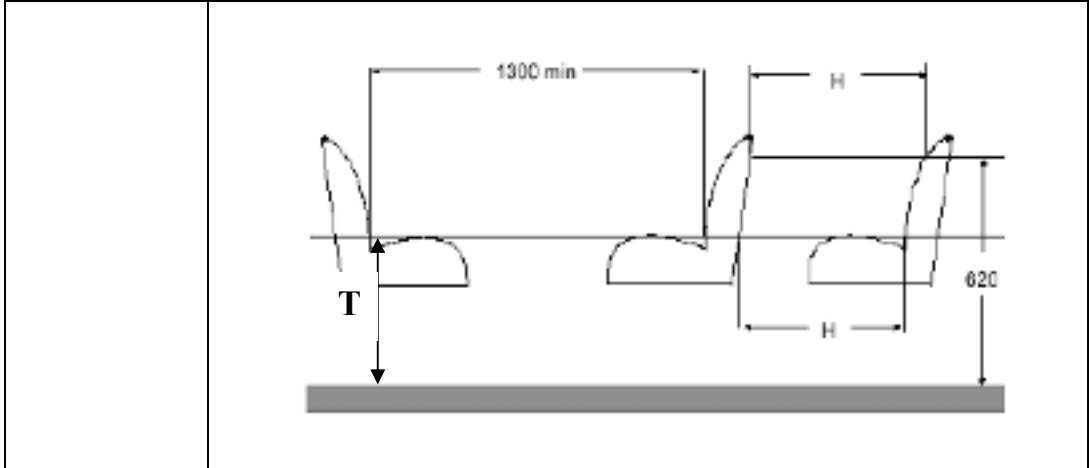
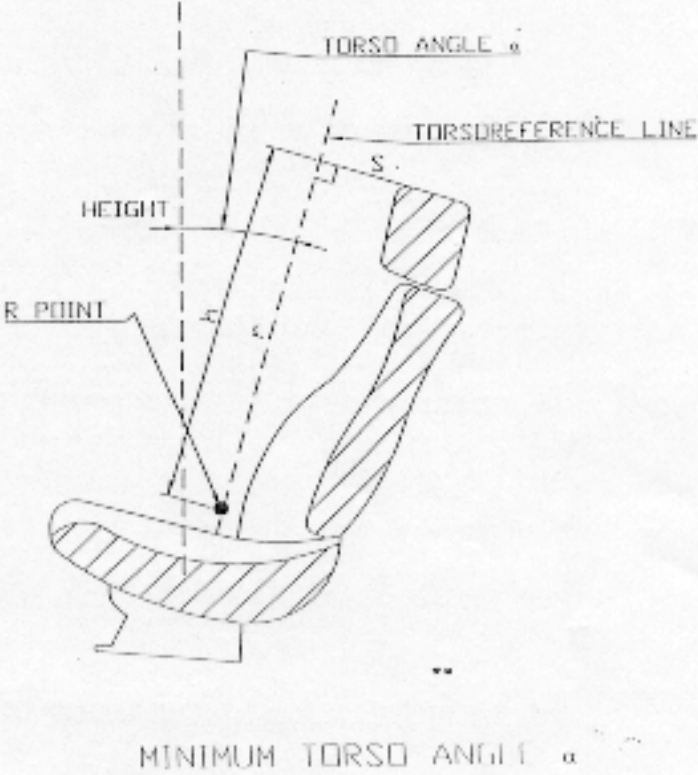

Figure 7
Seat Spacing

	NDX	SDX	DLX	ACX
Type I	650	650	650	650
Type II	680	680	680	680
Type III	-	680	680	680

	<p>Passenger Seat</p>  <p>MINIMUM TORSO ANGLE α</p>
	<p>Minimum torso angle</p>
	<p>NDX : 12 deg. SDX, DLX & ACX : 15 deg.</p>
	<p>Figure 8 Passenger seat torso angle</p>

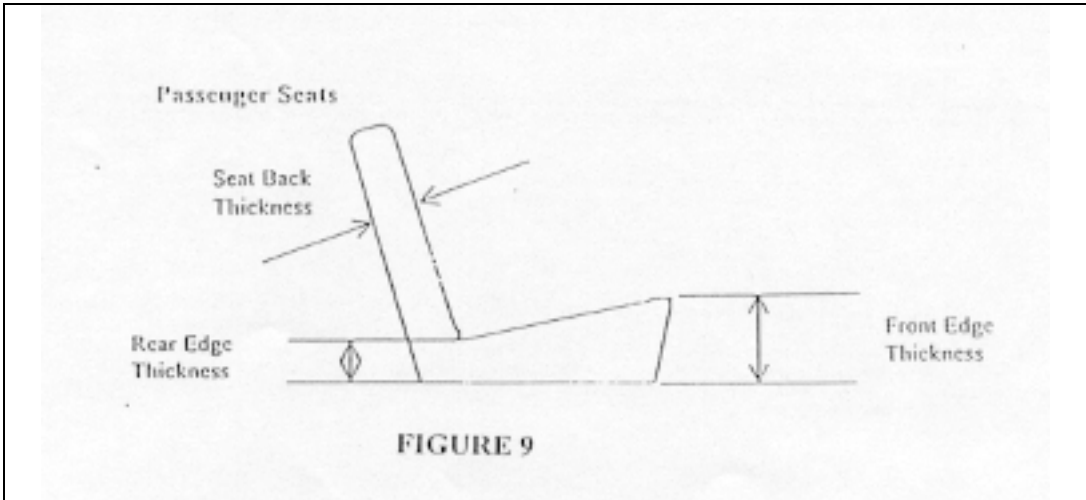

FIGURE 9

Seat Base Thickness

The thickness of seat base in mm may be as follows:

	Type I & II				Type III		
	NDX	SDX	DLX	ACX	SDX	DLX	ACX
Thickness of seat cushion front edge (min)	90	110	130	130	110	130	130
Thickness of seat cushion Rear edge (min)	60	80	100	100	80	100	100

Seat Back Thickness

The thickness of seat cushion back in mm may be as follows:

	NDX	SDX	DLX	ACX
Type I	25	25	50	50
Type II	25	50	75	75
Type III	-	50	75	75

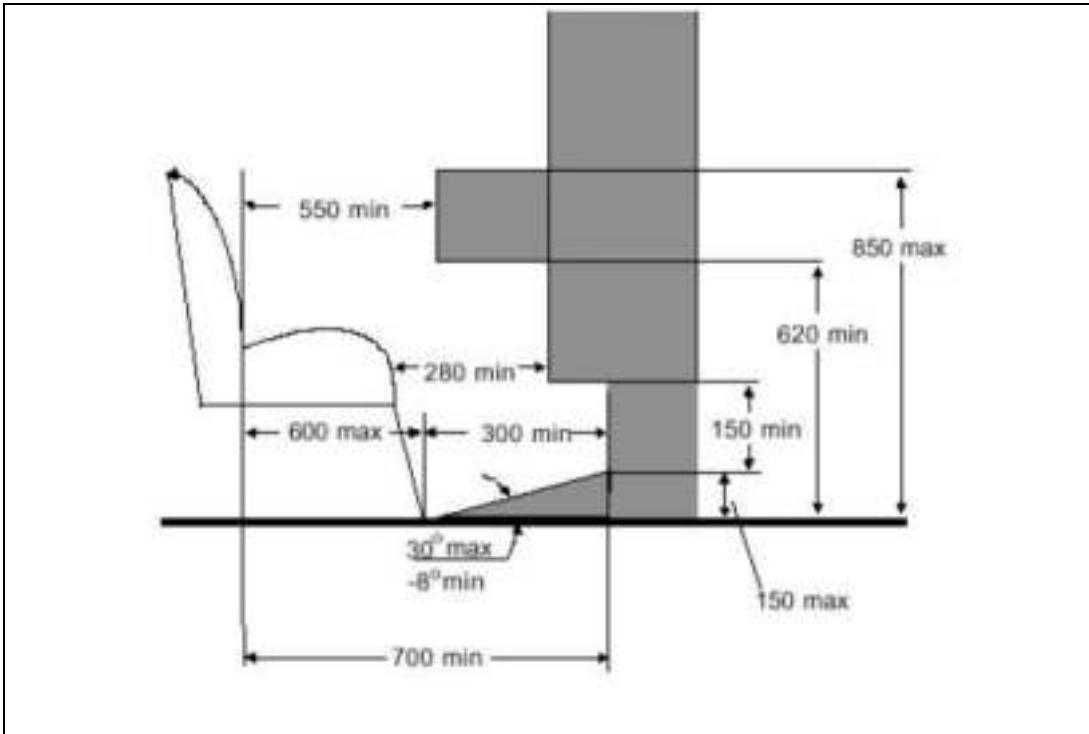

Figure 10
Passenger Seat Space for Seated Passenger

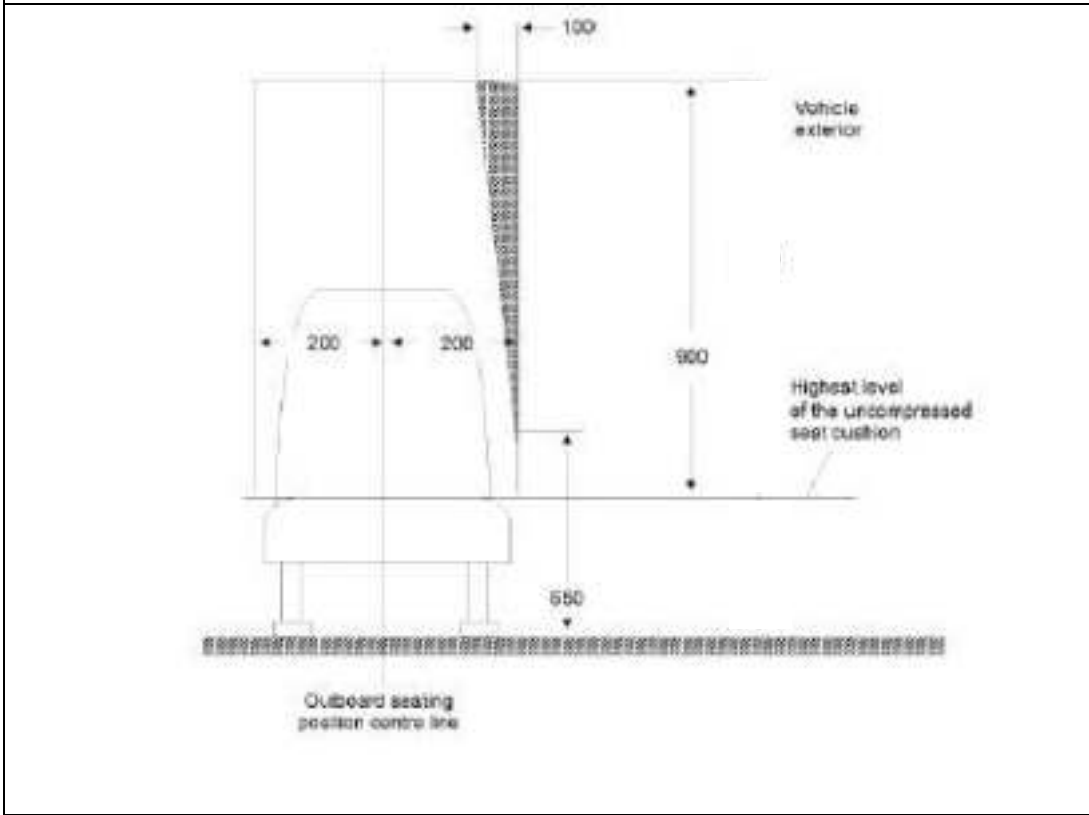

Figure 11
Permitted Intrusion above Seating Position

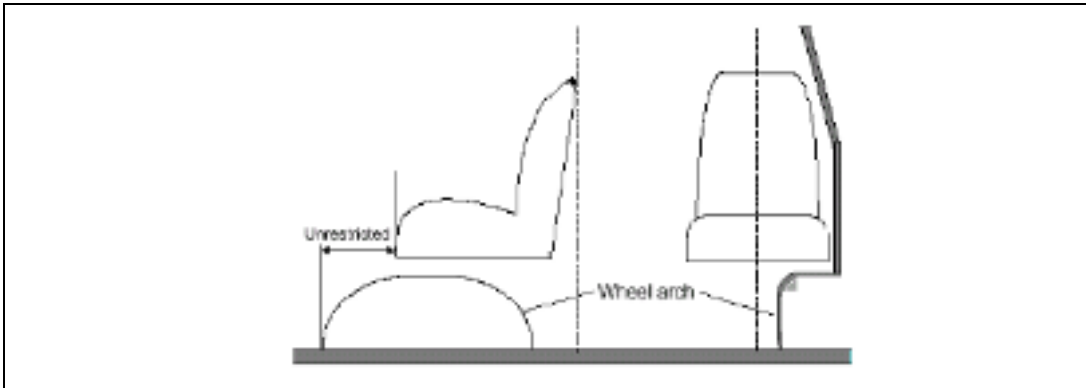

Figure 11A
Permitted Intrusion of a Wheel Arch not extending beyond the vertical centre line of the side seat

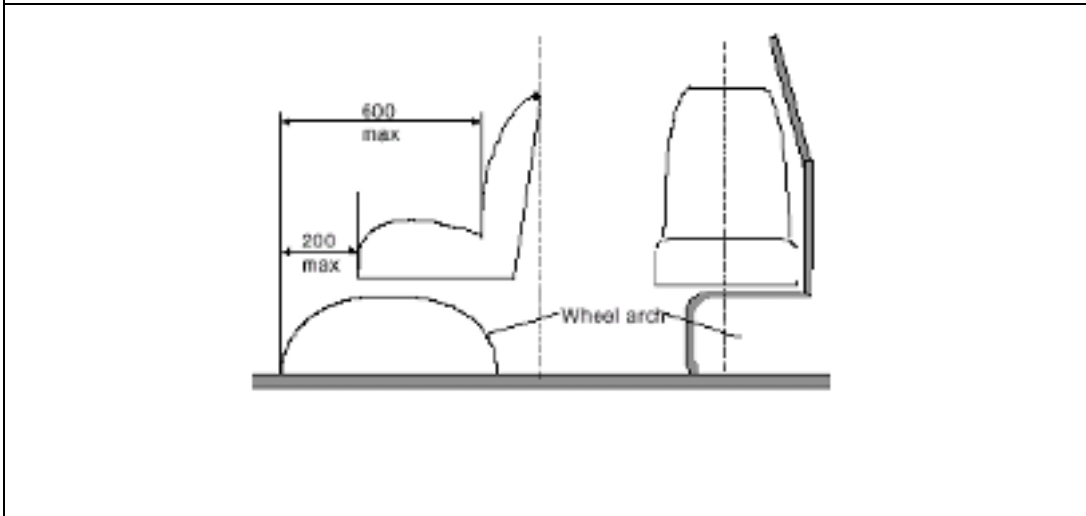

Figure 11B
Permitted Intrusion of a Wheel Arch extending beyond the vertical centre line of the side seat

Figure 12
Reserve

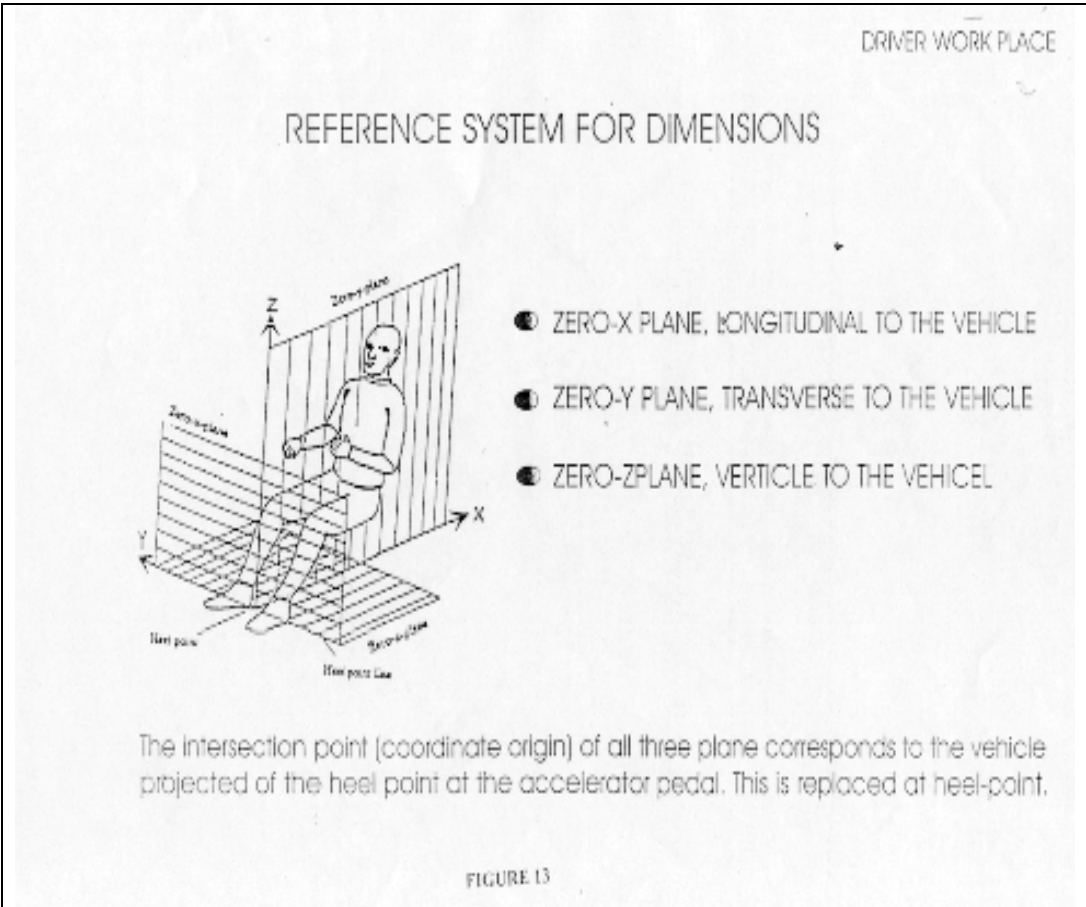
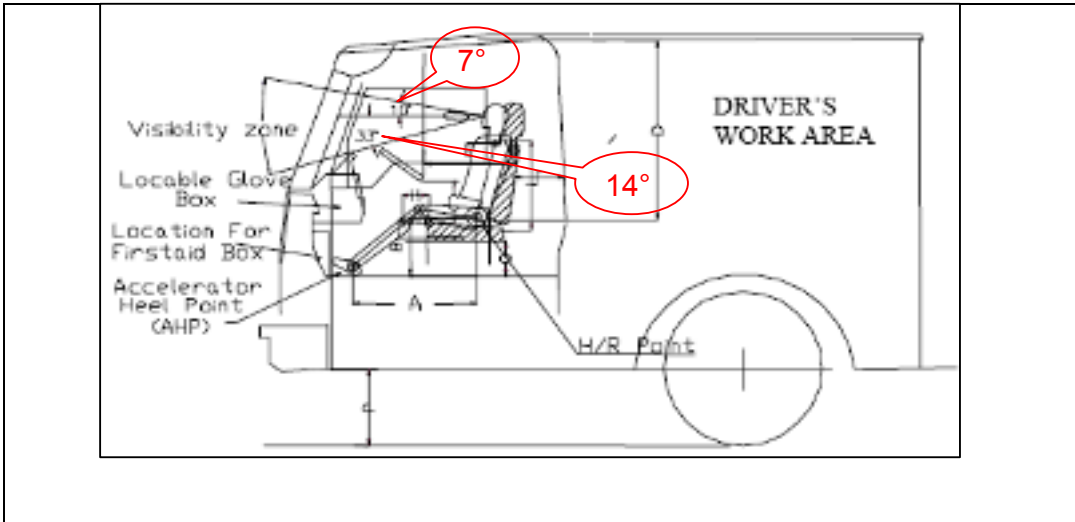

Figure 13



Dimensional Requirement

A	Distance from Heel Point to “H” Point	600 mm to 640 mm
B	Minimum Distance from floor to “H” Point with the driver’s seat in the upper most position	500 mm
C	Thigh Clearance	200 mm to 260 mm
D	Minimum Distance from “H” Point to Roof top	1060 mm
E	Minimum Distance from the lower end of steering to the front of driver’s seat back rest	350 mm
F	Minimum Distance of driver’s partition from the rear of the driver’s seat with the driver’s seat in the rear most position	25 mm

Figure 14

Driver’s Work Area Requirements

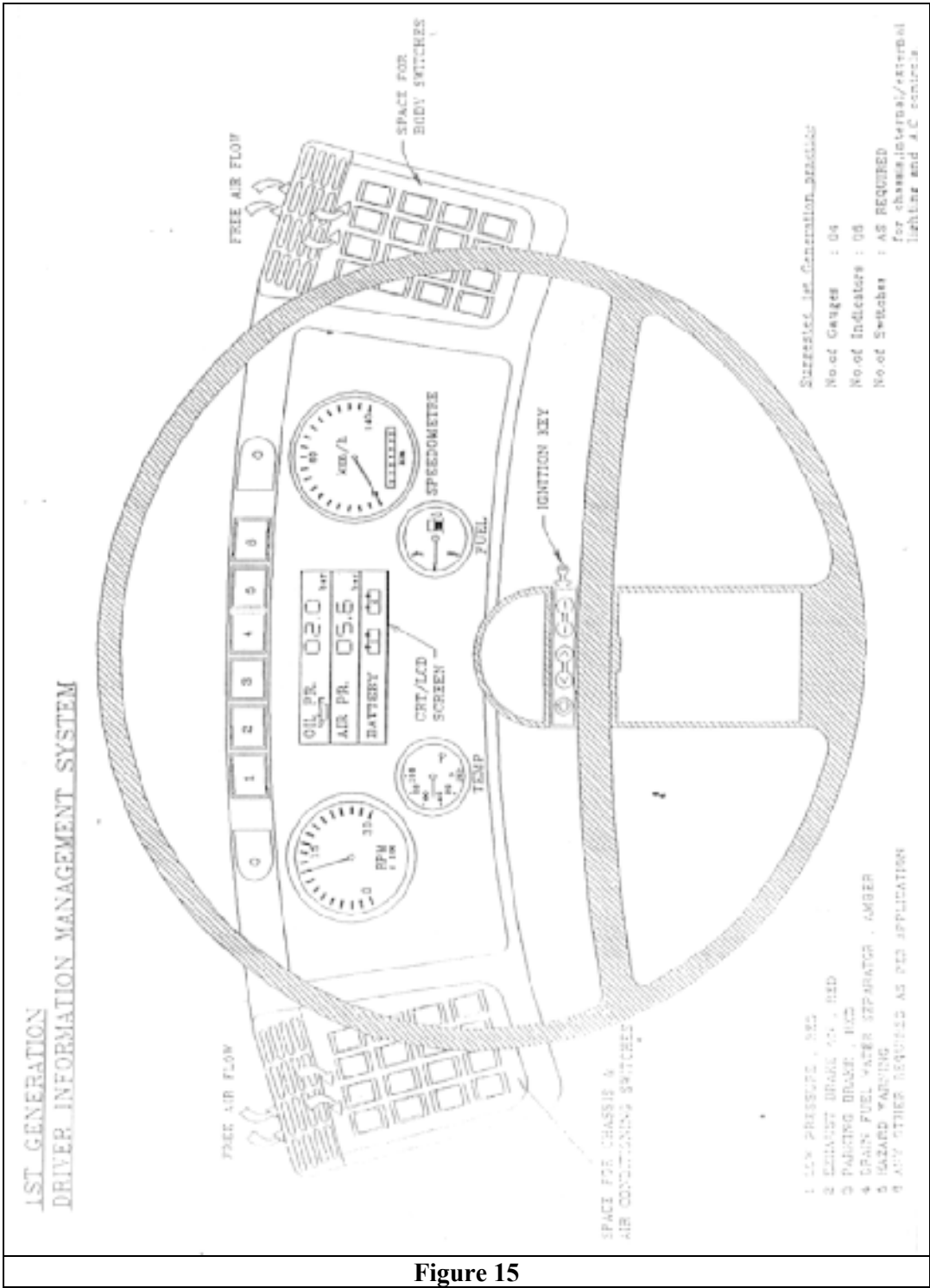

Figure 15



Figure 16
Pictogram for Passengers with Reduced Mobility

CHAPTER : 3**TECHNICAL & SAFETY REQUIREMENTS****3.1 Body Structure Strength**

- 3.1.1. The body structure of all single deck buses of Type II and Type III category excluding Mini buses, shall be of sufficient strength, to meet the test requirements in Chapter 6, para 6.1.

3.2 Body Structure Stability

Stability Test of the body structure of single as well as double deck vehicles of categories Type I, Type II, Type III & Type IV shall meet the requirements test defined in Chapter 6, para 6.2.

3.3 Reserved**3.4 Doors**

- 3.4.1 The structure of the door shall be able to withstand distortion due to forces induced during its operation and the operability of door components critical to the removal of the passengers after an accident shall be ensured.

- 3.4.2 The external side of the door shall not have any projection. The hinges and door handles shall meet requirements as specified in IS13942:1994, as amended from time to time.

- 3.4.3 Door shall be fitted with weather resistant EPDM rubber seals of suitable design to avoid dust and water ingress.

3.4.4 Service doors

- 3.4.4.1 All Type I buses, except NDX shall be provided with Power Operated Service Door(s). The Power Operated Service Door shall be optional in the Type I NDX buses. Type II & Type III buses shall be provided with Power Operated or Manually Operated Service Doors(s).

- 3.4.4.2 Service door shall be capable of being easily opened from inside and from outside the vehicle when the vehicle is stationary. However this requirement does not preclude the possibility of locking the door from the outside, provided the door can be always opened from inside.

- 3.4.4.3 The control or device for opening a service door from the outside shall be located at a height of 1000 mm to 1500 mm from the ground level. The measurement shall be carried out in the unladen condition on level surface

- 3.4.4.4 Single piece manually operated service door which is hinged or pivoted shall be such that in the event the open door comes in contact with a external object while the vehicle is in forward motion the door shall tend to close.

- 3.4.4.5 Where direct view is not adequate, optical or other devices shall be installed to enable the driver to detect from his seat the presence of a passenger in the immediate interior or exterior vicinity of every service door.
- 3.4.4.6 Manually operated service doors fitted with slam type lock shall be of the two stage type.
- 3.4.4.7 On the inside of a service door there shall not be any device intended to cover the inside steps when the door is closed. The door operating mechanism and other equipment attached to the inside door should not pose safety hazard for the passengers.
- 3.4.4.8 For every door which opens inwards, the mechanism shall be so constructed that its movement is not likely to cause injury to the passengers during normal use. Where necessary suitable protection devices may be provided.
- 3.4.4.9 **Additional Requirements for Power Operated Service Doors**
- 3.4.4.9.1 In the event of an emergency every power operated door shall be capable of
- being opened from inside when the vehicle is stationary even when locked from outside, by controls with or without power supply by which the door normally operates.
 - Overriding all the other door controls.
 - Being operated by a single person easily by hand.
 - The controls shall be easily seen and identified by a person approaching the door or standing in Front of the door.
 - The interior controls are placed on or within 300 mm of the door, at a height not less than 1,000 mm above the first step.
- 3.4.4.9.2 The construction and control system of every power operated service door be such that a passenger is unlikely to be injured by the door or trapped between the door while closing. The door system shall meet the test requirements defined in Test methods para 6.5.
- 3.4.4.9.3 The movement of the doors shall not be abrupt.
- 3.4.4.10 **Additional Requirements for Automatic doors**
- 3.4.4.10.1 **Activation of opening circuits**
- 3.4.4.10.1.1 The opening controls of every automatically operated service door shall be capable of being activated and deactivated only by the driver from his seat. However provision in para 3.4.4.9.1 shall apply in the event of an emergency.

- 3.4.4.10.1.2 Activation of opening controls by the driver shall indicate the status by means of indicators (illuminated push button/sign) placed on or adjacent to the door whose control has been activated.
- 3.4.4.10.2 **Opening of automatically operated Service Doors**
- 3.4.4.10.2.1 After activation of the opening controls by the driver, the passenger shall be able to open the door by one of the methods below :
- from inside by a push button control or a passing through a light barrier.
 - from outside by a illuminated push button clearly indicating status.
- 3.4.4.10.3 **Closing of automatically operated Service Door**
- 3.4.4.10.3.1 The automatically operated service door shall close automatically after a time interval of opening of the door. If a passenger enters or exits during this time interval, a safety device (e.g. a foot board contact, light barrier) shall ensure that the time until the door closes is sufficiently extended.
- 3.4.4.10.3.2 If a passenger enters or exits while the door is closing, the closing process shall be interrupted and the door shall return to the open position.
- 3.4.5 **Emergency Exits**
- 3.4.5.1 **Emergency Doors**
- 3.4.5.1.1 The emergency doors shall be capable of operation from both inside and outside when operated manually. However this requirement shall not be construed as precluding possibility of locking the door from outside provided the door can be opened from inside.
- 3.4.5.1.2 The outside handles of emergency doors shall lie within 200 mm on either side of centreline of the door drawn in the horizontal plane. However, the position of the outside handle shall not be more than 1800 mm above the ground level in the unladen condition.
- 3.4.5.1.3 Doors shall be hinged at the forward edge and in case of horizontal door the hinge shall be on the top edge.
- 3.4.5.1.4 Emergency doors shall not be power operated or of sliding type.
- 3.4.5.1.5 Emergency doors shall open outward and shall be capable of remaining open outwards and at an angle of atleast 100°, such that aperture is clear of any obstructions.
- 3.4.5.1.6 Door check, stay or strap which is capable of meeting requirements specified in para 3.4.5.1.5 may be used.
- 3.4.5.1.7 The forward edge of the emergency door shall be behind or in the same transverse plane tangent to the rear-most point of a seat back adjacent to it.
- 3.4.5.1.8 All emergency doors shall be provided with an audible device to warn the driver when the emergency doors are not securely closed. The warning device shall operate due to the movement of the door catch and not by the movement of the door itself.

3.4.5.2 Emergency Windows

- 3.4.5.2.1 Emergency windows equipped with ejection type of construction shall be meet the requirement specified in IS 13944:1995.
- 3.4.5.2.2 Every hinged or executable emergency window shall open outwards.
- 3.4.5.2.3 Every emergency window shall:
 - 3.4.5.2.3.1 either be capable of being easily and instantaneously operated from inside and from outside the vehicle by means of a device, or
 - 3.4.5.2.3.2 be made of readily breakable safety glass. In such case a device shall be provided adjacent to each emergency window, available to the person in the vehicle for ready access for breaking the window. The window glass shall be made of safety glass as specified by Bureau of Indian Standards and shall readily break on impact when hit by a hammer in the event of an emergency.
- 3.4.5.2.4 Every emergency window which can be locked from outside shall be constructed such that it shall be capable of being opened at all times from inside.
- 3.4.5.2.5 Emergency window where horizontally hinged at the top edge shall be provided with a suitable stay to hold the door fully open. Every emergency window shall operate such that it does not obstruct clear passage.
- 3.4.5.2.6 Every hinged emergency window which is not visible from the driver's seat shall be fitted with a audible warning device to warn failure of locking system.

3.4.5.3 Escape Hatches

- 3.4.5.3.1 Escape hatches shall be ejectable, hinged or readily breakable safety glass. Operation of escape hatch shall not obstruct clear passage from inside or outside the vehicle. Ejectable type hatches shall not detach from the vehicle fully.
- 3.4.5.3.2 Escape hatches shall be capable of being easily operated from inside and from outside the vehicle. However this requirement shall not be construed as precluding the possibility of locking the escape hatch for the purpose of securing the vehicle when unattended, provided that the escape hatch can always be opened from inside the vehicle.
- 3.4.5.3.3 In case breakable safety glass is provided, a device shall be provided for breaking the escape hatch.

3.4.5.4 Marking of Emergency Exits

- 3.4.5.4.1 All emergency exits shall be prominently designated in red letters in English when viewed from inside. Concise operating instructions describing each motion necessary to unlatch and open the exit shall be displayed. These instructions shall be located within 150 mm of the release mechanism.









" EMERGENCY EXIT "
 or
 " EMERGENCY DOOR"
 and by symbols

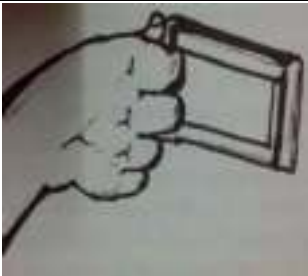
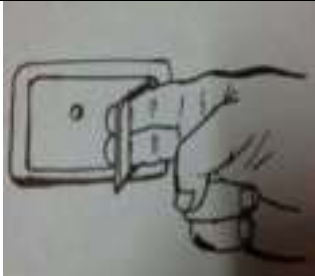

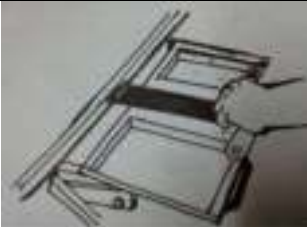
when viewed from inside. Concise operating instructions describing each motion necessary to unlatch and open the exit shall be displayed. These instructions shall be located within 150 mm of the release mechanism.

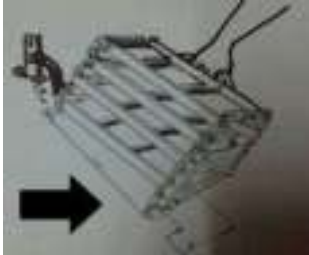
3.4.5.5 Safety Signs - General Requirements.

- 3.4.5.5.1 Each safety sign required by this Standard shall be used to communicate only one safety message. The information provided shall be in the form of pictograms, however, words, letters and numbers may supplement the pictogram in combination on the same sign. It shall be located and orientated so as to be easily understood.
- 3.4.5.5.2 Pictograms indicating a required action by the user shall show a person, or the relevant part of a person, operating the equipment or control device.
- 3.4.5.5.3 Pictograms indicating a required movement shall, where appropriate, show an arrow pointing in the direction of motion. Where a rotational movement is required, a curved arrow shall be used. Safety signs shall follow the principles shown in the example layouts below;
- 3.4.5.5.4 Where devices are to be operated, panels removed or doors opened, the pictogram shall indicate the action in progress.
- 3.4.5.5.5 The lower case letter(s) of supplementary words, single letters and numbers shall have a minimum height of 10 mm.
- 3.4.5.5.6 All safety signs shall be of photo-luminescent material.
- 3.4.5.5.7 All safety signs shall comprise a Red pictogram on a White colour background.
- 3.4.5.5.8 Safety signs identifying the control or the device for breaking/opening emergency windows/doors shall be positioned adjacent to, or surround all internal and external emergency controls for all exits.
- 3.4.5.5.9 Safety signs shall not be located in positions where they may be obscured during operation of the vehicle. However, a curtain or blind may be positioned over an emergency window provided an additional safety sign indicates that the emergency window is located behind the curtain or blind.

ALERT NOTICE (INSIDE THE DOOR)		
	(2)	(3)
		
Emergency Exit Door	Lift the cover to access lock.	Lift the handle to unlock
(4)	(5)	(6)
		
Push the door to open	Release the strap of emergency foot strap	Rotate the step to engage
(7)	(8)	
		
Push the step out	Start Evacuation	
ALERT NOTICE (OUTSIDE THE DOOR)		
(9)	(10)	(11)
		
Break the glass	Lift the handle	Stay away from the door

3.4.5.6 Technical requirements for Retractable/Collapsible steps (if fitted) :

Retractable/Collapsible steps if fitted shall comply with the following requirements:

- 3.4.5.6.1 The operation of Retractable/ Collapsible steps may be synchronized with that of the corresponding service or emergency door;
- 3.4.5.6.2 When the door is closed no part of the Retractable step shall project more than 10 mm beyond the adjacent line of the body work. Similarly, the collapsible step in non-usage position shall not intrude into passenger seat space or obstruct the emergency door access by more than 10mm.
- 3.4.5.6.3 When the door is open and the Retractable/Collapsible steps is in the extended position, the steps shall conform to the requirements of paragraph 2.2.5 of this standard;
- 3.4.5.6.4 In the case of a manually operated step, when the step is in the extended position, an audible indication shall alert the driver when the step is not fully retracted or the emergency door is open.
- 3.4.5.6.5 If the device to operate the step fails, the step shall remain in the retracted position/original position. However, the operation of the corresponding door shall not be hindered in the event of such a failure or by the step being damaged or obstructed.
- 3.4.5.6.6 The corners of Retractable/Collapsible steps facing forwards or rearwards shall be rounded to a radius of not less than 5 mm; the edges shall be rounded to a radius of not less than 2.5 mm;
- 3.4.5.6.7 When the passenger/emergency door is open, the Retractable/Collapsible step shall be securely held in the extended position. When a mass of 136 kg is placed in the centre of a single step or a mass of 272 kg is placed in the centre of a double step the deflection at any point on the step, measured relative to the body of vehicle, shall not exceed 50 - 60 mm.

3.5 Door Components

- 3.5.1 Door components shall meet the requirements specified in Rule 124 of CMVR. The door components shall be meet requirements specified in para 6.6.

Table 1	
Standards Related to Door Components	
Description	Standard No
Automotive Vehicles:- locking systems and door retention components – general requirement	IS 14225-1995*
Automotive Vehicles:-window retention and release systems for buses	13944-1994*
* As amended from time to time	

3.6 Window

3.6.1 Where windows with glazing are provided the glazing shall meet requirement specified as in para 3.6.2 & 3.6.3.

3.6.2 Window Glazing

3.6.2.1 The window glass shall be made of safety glass as specified in IS 2553 Part 2 and shall readily break on impact when hit by a hammer in the event of an accident.

3.6.3 Thickness of glazing

3.6.3.1 Minimum glazing thickness for windows, shall be as per IS:2553 (Part-2) as amended from time to time.

3.6.4 Edges

3.6.4.1 The edge shall be crown edge, satin finish for all the exposed edges that is likely to come in touch with the passenger's body. (This Edge specification corresponds to Edge No. 1 specified in SAE J673).

3.6.5 Window Frames

3.6.5.1 The glazing may be mounted on frame; constructed from aluminum extrusions or formed steel/coated sections. Alternately directly, sliding on flocked rubber channels supported by aluminum/steel section.

3.6.5.2 The window frames shall be mounted such that distortions and change of aperture dimensions due to forces on the structure does not deform the guideways. The window glass/glass and frame shall slide smoothly when subjected to normal pull force (50 to 75N)

3.6.5.3 The window frame shall be attached to the structure by weather strips or bonded with adhesive or any other suitable method.

3.6.5.4 The mounting shall meet requirement specified in BIS Standard- Window retention and release system for Buses Safety Requirement IS 13944-1994. However, this requirement shall not be applicable for Mini buses whose Gross Vehicle Weight (GVW) is less than 3.5 tons.

3.6.5.5 The window frame fitted on buses shall meet the requirements specified in AIS-068 as amended from time to time however AIS-068 shall not be applicable for pasted or fixed glass windows

Table 2	
Related standards for Window Glazing	
Description	Standard No
Safety Glasses: Part 2 for Road transport	IS 2553 Part 2*
Window retention and release system for Buses:- Safety Requirement	IS: 13944-1994*
Water Proofing Test on Automobiles	IS 11865-1992*
* As amended from time to time	

3.7 Ingress of dust and rain water :

- 3.7.1 All body joints, front safety glass, rear safety glass, doors, windows and hatches should be so constructed such that it does not permit ingress of rain water, in the fully closed condition. It is recommended that the bus body builders carry out their own internal assessment test to check water proofing as per IS : 11865 – 1992.
- 3.7.2 All body joints, front safety glass, rear safety glass, doors, windows and hatches should be so constructed such that it does not permit ingress of dust, in the fully closed condition. It is recommended that the bus body builders carry out their own internal assessment test to check dust ingress as per IS : 11739 – 1986 as amended from time to time.
- 3.7.3 Drain holes shall be provided in the window frame such that water shall flow outward and does not flow into the structure cavity or into the passenger compartment.

3.8 Body Insulation

- 3.8.1 Body insulation shall be provided with suitable material for DLX and ACX buses and optional for other categories. It is recommended to use materials like Polyurethane or Glass Wool of minimum thickness of 40 mm and minimum density of 40 kg/m³. Materials superior to the ones shall also be permitted.

3.9 Rear View Mirrors

- 3.9.1 The rear view mirrors shall meet the requirements specified in AIS Standards AIS-001 and AIS-002 as amended from time to time.

3.10 Wind Screen Wiping System and Driver's field of Visions

- 3.10.1 The Wind Screen Wiping System shall meet the requirements specified in IS-15802:2008 as amended from time to time.

3.11 Vehicle Seats and Seat Belts

- 3.11.1 All Seat designs and Seat anchorage designs used in buses, shall meet the requirements of AIS-023 as amended from time to time.
- 3.11.2 All types of buses shall be provided with seat belts as per the provisions of CMVR. The seat belts assemblies and their anchorages shall meet the requirements of AIS-005 and AIS-015 as and when notified separately under CMVR.
- 3.11.3 The Seats used in buses shall be those which are type approved by the testing agency as per AIS-023, as amended from time to time.

3.12 Reserve**3.13 Pad Material**

The recommended pad material for various types / categories of buses are as given in table below. Materials superior to the ones indicated in this table shall also be permitted.

		Fibre glass / Polymer (moulded)	PU Foam	Rubbe rised coir	Latex foam	Moulded P.U. Foam
Type I	NDX	✓	✓	✓		
	SDX		✓			
	DLX				✓	✓
	ACX				✓	✓
Type II	NDX			✓	✓	
	SDX		✓			
	DLX				✓	✓
	ACX				✓	✓
Type III	SDX			✓		
	DLX					✓
	ACX					✓

3.14		Upholstery				
The recommended upholstery for various types / categories of buses are given in table below. Materials superior to the ones indicated in this table shall also be permitted.						
			PVC Rexene	Foam Rexene	Tapestry Cloth	Velvet Cloth
Type I	NDX		✓			
	SDX			✓		
	DLX				✓	✓
	ACX				✓	✓
Type II	NDX		✓			
	SDX			✓		
	DLX				✓	✓
	ACX				✓	✓
Type III	SDX			✓		
	DLX				✓	✓
	ACX				✓	✓

3.15		Other Features									
The recommended features for various types / categories of buses are given in table below. However, features superior to the ones indicated in this table may also be permitted.											
Feature	Type I				Type II				Type III		
	NDX	SDX	DLX	ACX	NDX	SDX	DLX	ACX	SDX	DLX	ACX
Head Rest			✓	✓			✓	✓	✓	✓	✓
Seat Arm			✓	✓		✓	✓	✓	✓	✓	✓
Seat Back-Fixed	✓	✓			✓	✓			✓		
Seat Back - Reclining			✓	✓			✓	✓		✓	✓

Magazine Pouch			✓	✓			✓	✓		✓	✓
Folding Table for Food Tray										✓	✓
Water bottle holding fixture							✓	✓		✓	✓
Fan on each row (min. of 12 Watts)			✓				✓			✓	
Reading Lights				✓			✓	✓		✓	✓

Table 3			
Recommended Specifications for moulded polyurethane cushion :			
Sl. No.	Characteristic	Specification	Test Method
1.0	Density	40 - 60 kg/m ³	As per IS 7888 – 1976
2.0	Compression set	12 % Max.	As per IS 7888 – 1976
3.0	Tensile test	1.2 to 1.9 kg/cm ²	As per IS 7888 – 1976
4.0	Elongation	110% Min.	As per IS 7888 – 1976
5.0	Resilience	58 - 63 %	As per JIS K 6401
6.0	Rebound fatigue	1,00,000 cycles	As per ISO 3385-1989
	Reduction in height	8% Max.	
	Reduction in hardness	12% Max.	
7.0	Flammability requirements for the foam & upholstery		As per IS 15061:2002

Table 4	
Related Standards for Cushion / Pad Materials	
Description	Standard No
Molded Rubberize Coir Cushion	IS 11060 :1984
Latex Foam Rubber Products	IS 1741:1960

Table 5	
Related Standards for Upholstery	
Description	Standard No
Vinyl Coated Fabric	IS 1259:1984
Expanded Vinyl Coated Fabric	IS 8698
PVC Coated Fabric	IS 3322 Part I : 1987
Rayon Velvet	IS 4439:1988
Textile Covering – Tufted Carpet	IS 5884:1995
Jacquard	

3.16 Reserved

3.17 Corrosion Protection

3.17.1 The quality of the surface treatment shall be tested according to the test methods specified in JIS D0202 or any equivalent standards including BIS Standard. (General Rules of Coating Films for Automotive Parts or equivalent Indian Standards using test panels.) The minimum quality requirements in table below shall be met for test criteria specified in para. 4 of JIS D0202. The compliance to this requirement shall be demonstrated by the body builder to the testing agencies.

Painted or coated panels	Quality		
Surface Condition – Appearance	There must be no surface roughness, pin holes or other harmful defects.		
Corrosion Resistance or Water / moisture resistance	96 (Hrs)		
Oil Resistance (40 Deg. 24 hrs)h	No swelling, flaking, peeling, cracking, film softening nor appreciable change in lustre or colour		
Volatile Oil Resistance (Gasoline) (24 hrs)	No swelling, flaking, peeling, cracking, film softening nor appreciable change in lustre or colour		
Pencil Scratch Test	Shall resist HB or Harder		
Checker Mark : No of sections in which film remains intact (without peeling off) Grade 3 shall apply only to Copper and copper alloy bases, Aluminum and aluminum alloy bases and Zinc and Zinc alloy bases	Grade 1	Grade 2	Grade 3
	100	90 or more	60 or more

Note: Bus Body Manufacturer should provide relevant internal reports or a declaration for compliance for relevant structural and body parts to respective standard.

3.18 Protection against fire risk

3.18.1 Engine Compartment

3.18.1.1 No flammable sound proofing material or material liable to impregnated with fuel, lubricant or any combustible material shall be used in the engine compartment unless the material is clad by an impermeable sheet.

3.18.1.2 Precaution shall be taken, either by suitable layout of the engine compartment or by provision of drainage orifices to avoid as far as possible, the accumulation of fuel, lubricants or any other combustible material in any part of the engine compartment.

- 3.18.1.3 A partition of heat-resistant material shall be fitted between the engine compartment and any other source of heat (e.g. a retarder designed to absorb energy liberated when descending along gradient). Any device designed for employing warm water shall be precluded from this requirement. All mounting clips gaskets etc. used in conjunction along with the device shall be fire resistant.
- 3.18.2 **Fuel filler apertures**
- 3.18.2.1 Fuel filler apertures shall be accessible only from exterior of the vehicle.
- 3.18.3 **Fuel Tank**
- 3.18.3.1 Position of filler aperture shall be as fitted by the vehicle manufacturer. Alteration/ relocation of the fuel tank shall not be permitted unless approval obtained from the vehicle manufacturer and test agency.
- 3.18.3.2 No part of the fuel tank shall project beyond the overall width of the body work.
- 3.18.4 **Fuel feed System**
- 3.18.4.1 Alterations shall not be permitted on fuel feed system provided by the vehicle manufacturer. The Coach builder shall obtain Type approval for carrying out any modification prior to any alteration if deemed necessary.
- 3.18.4.2 No apparatus used for the fuel feed shall be placed in the driver's compartment or the passenger compartment.
- 3.18.4.3 Fuel lines and all other parts of the fuel feed shall be accommodated in the vehicle where they have the optimum protection.
- 3.18.4.4 It is recommended that twisting and bending movements and vibrations of the vehicle or the power unit do not subject the fuel lines to abnormal stress. It is also recommended that the union of pliable pipes with rigid parts of fuel feed system must be so designed and constructed as to remain leak proof in various condition of use of the vehicle despite ageing, twisting or bending movements, or vibration of the vehicle structure or power unit. Fuel leaking from any part of the engine system be able to flow away freely to the road surface, but never into the exhaust system.
- 3.18.5 **Fire extinguishers**
- 3.18.5.1 The vehicle shall be equipped with one or more Fire extinguishers, one being near to the driver's seat.
- 3.18.5.2 Type and the minimum number of extinguishers to be provided shall be as follows:

Total Capacity of extinguisher	Standard bus			Midi & Mini bus	
	Type I	Type -II	Type III	Midi Bus	Mini Bus
10 kg rating for Standard Bus (Other than Midi and Mini Buses) & 4 kg rating for Midi and Mini Buses) 21A 113B CEN Std EN 3 Pt.1	-Minimum two nos. of fire extinguishers shall be provided. -Minimum capacity shall be 2kg. -Total capacity shall be 10kg.	-Minimum two nos. of fire extinguishers shall be provided. -Minimum capacity shall be 2kg. -Total capacity shall be 10kg.	-Minimum two nos. of fire extinguishers shall be provided. -Minimum capacity shall be 2kg. -Total capacity shall be 10kg.	-Minimum two nos. of fire extinguishers shall be provided. -Minimum capacity shall be 1kg. -Total capacity shall be 4kg.	-Minimum two nos. of fire extinguishers shall be provided. -Minimum capacity shall be 1kg. -Total capacity shall be 4kg.

Note : Fire extinguishers shall comply with IS : 13849 or IS : 2171 as amended from time to time, as may be applicable

- 3.18.5.3 Halogenated hydrocarbon type of extinguisher shall not be used as extinguisher.
- 3.18.5.4 Fire extinguisher shall be secured against tampering and shall be kept at an easily accessible location.

3.19 First aid Equipment

- 3.19.1 First Aid Kits containing items notified under Rule 138 (4) (d) of CMVR 1989 shall be provided.
- 3.19.2 Space shall be provided for fitting more than one first-aid kit.
- 3.19.3 The First aid kits shall be secured against tampering and shall be kept in lockers or behind breakable glass. The location shall be marked clearly.

3.20 Modification of Chassis and / or Chassis related Components

- 3.20.1 Alterations shall not be permitted on the chassis or any of its aggregates or components. Any modifications shall call for fresh type approval of the design and the prototype.

3.21 A.C. System

- 3.21.1 The A.C. system shall meet the technical and safety requirements as and when notified.

3.22 Interior Noise

- 3.22.1 The interior noise level shall be in accordance with AIS-020 as amended from time to time.

CHAPTER : 4
LIGHTING & ILLUMINATION

4.1 Lighting, Signalling and Indicating Systems-

4.1.1 External

4.1.1.1 External lighting and light-signaling devices of the bus shall comply with the Rules laid down under the Central Motor Vehicle Rules, 1989, and as amended from time to time.

4.1.1.2 All lighting and light-signaling devices shall be Type Approved”

4.1.2 Internal

4.1.2.1 Lighting and light-signaling devices shall provide adequate illumination inside the bus for the safe operation by the driver and the passengers, during darkness and other conditions of reduced visibility.

4.1.2.2 Position of illumination devices

4.1.2.2.1 The following lamps are to be placed on the roof of the bus, above the head of the observer -

- Cab lamp or courtesy lamp
- Passenger area lamps

4.1.2.2.2 The following lamps are to be placed at door apertures -

- Exit lamps

4.1.2.2.3 The following lamps are to be placed inside the compartment/unit/control

- Locker lamp
- Electrical distribution centre lamp - Instrument lighting
- Control unit lamps

4.1.2.3 Type of Bulbs for lamp Assemblies

4.1.2.3.1 The following lamp assemblies can be illuminated either by incandescent bulbs or L.E.D (Light Emitting Diodes) or any other suitable light source –

- Tell-Tale lights
- Instrument lights
- Control unit lamps”

4.1.2.3.2 The following lamp assemblies can be illuminated by incandescent bulbs or any other suitable light source

- Electrical distribution centre lamp
- Locker lamp

- 4.1.2.3.3 The following lamp assemblies can be illuminated by incandescent bulbs or fluorescent bulbs or L.E.D. (Light Emitting Diodes) or any other suitable light source –
- Entrance lamps
 - Cab lamp or courtesy lamp
 - Passenger area lamp
- 4.1.2.4 **Photometric requirements**
- 4.1.2.4.1 Lighting requirements of the Lighting and light-signaling devices for the following sub groups:-
- Dash Board Tell tale lighting/Control lighting
 - Driver Cabin lighting
 - Passenger Compartment lighting
 - Other Area lightings
- 4.1.2.4.1.1 **Dash Board Tell tale lighting/Control lighting**
- 4.1.2.4.1.1.1 Lamps falling in this category –
- Instrument lighting
 - Tell-tale lighting
 - Control unit lamps
- 4.1.2.4.1.1.2 The lighting devices used for dash board shall be discreet and shall not disturb the driver when driving in the dark.
- 4.1.2.4.1.1.3 The strength of the instrument lighting can be capable of regulation through a rheostat or any other suitable means, optionally.
- 4.1.2.4.1.2 **Driver Cabin lighting**
- 4.1.2.4.1.2.1 The following lamps fall in this category :
- Cab lamp or courtesy lamp
 - Locker lamp
 - Electrical distribution lamp
- 4.1.2.4.1.2.2 The lighting devices used for cabin interior should be sufficient enough for clearly distinguishing each component part of the cabin. The driver should be in a position to read signages written on the walls, door of the cabin. He should also be in position to read any instructions printed on paper.

4.1.2.4.1.2.3 The luminous flux of all the lamps provided for cabin lighting to light up the equipment, components and to read, shall not be less than 30 lux and shall not be more than 150 lux, when measured at 500 mm above the driver seat base.

4.1.2.4.1.2.3.1 The driver's compartment shall be provided with illumination through separate circuit.

4.1.2.4.1.3 **Passenger Compartment lighting**

4.1.2.4.1.3.1 The following lamps fall in this category:-

- Exit lamps
- Passenger area lamps

4.1.2.4.1.3.2 The lighting devices used for passenger area should ensure reading of signages inside the passenger area and other important signs like emergency signs. The illumination should light up handles, latches, knobs, rods, hand-holds, etc facilitating easy access to passenger. The illumination should be adequate for reading printed matter by the passenger.

4.1.2.4.1.3.3 The illumination of these lamps shall not be less than 50 lux, when measured at any seating location of the bus and at 500 mm above the seat base.

4.1.2.4.1.3.4 At least two night lights shall be provided in the passenger compartment of all buses except Type I buses. The interior lighting shall be designed such that the glare and reflections caused does not affect the driver.”

4.1.2.4.1.4 **Other Area Lightings**

4.1.2.4.1.4.1 Luggage hold area lighting : Every luggage hold shall be provided with light fittings for illuminating the hold when in use.

4.1.2.4.1.4.2 Destination panel lighting: The front, rear and side (optional) of the vehicle shall be illuminated or self illuminated (e.g. LED based destination boards) in such a way that the inscription on the panel/board shall be visible at a distance of 30 metres.

4.1.2.4.1.4.3 Side marker lamp: These are to be mounted on the side of the vehicle and shall be of amber colour. They shall be mounted on a height of 250 – 1500 mm above the ground.

4.2 **Type Approval**

4.2.1 The lighting and light-signaling devices fitted in buses shall be type approved for performance as well as installation requirements as notified under Central Motor Vehicles Rules, 1989 and as amended from time to time.

4.2.2 All the above information shall be incorporated in the technical specification submitted for the type approval.

CHAPTER : 5
ELECTRICAL EQUIPMENT AND WIRING

5.1 Electrical cables

- 5.1.1 All cables used shall be compliant with BIS / DIN / ISO / SAE / JIS or JASO or other equivalent standard and shall be able to withstand working temperature upto 70°C.
- 5.1.2 All the cables shall be ducted and secured at suitable places in such a manner that during normal use of vehicle the cables are not subjected to any tension, stretching, nicking, cutting, abrasion or chaffing.
- 5.1.3 The conductor cross section shall be selected to carry the rated current as given below or according to one of the standards mentioned in para 5.1.1:-

Specification for Low Tension Wire for Automotive Application

Allowable Current (A)	Number/ Diameter of wire in (mm)	Cross Sectional Area in (mm ²)	Outer Diameter (mm)	Finished Outer Diameter (mm)
9	7/0.32	0.5629	1.0	2.2
12	11/0.32	0.8946	1.2	2.4
15	16/0.32	1.267	1.5	2.7
20	26/0.32	2.081	1.9	3.1
28	41/0.32	3.287	2.4	3.8

Table 1. Electrical copper conductors for motor vehicles Single-core, untinned, PVC-insulated. Permissible working temperature: 70°C. ²⁾							
Nominal conductor cross-sectional area mm ²	Approx. number of individual strands ¹⁾	Maximum impedance per meter ¹⁾ at + 20°C m Ω/m	Maximum conductor diameter ¹⁾ mm	Nominal thickness of insulation ¹⁾ mm	Maximum external diameter of insulated wire ¹⁾ mm	Permissible continuous current (guide figure) ²⁾ at ambient temperature of	
						+ 30°C A	+ 50°C A
1	32	18.5	1.5	0.6	2.7	19	13.5
1.5	30	12.7	1.8	0.6	3.0	24	17.0
2.5	50	7.60	2.2	0.7	3.6	32	22.7
4	56	4.71	2.8	0.8	4.4	42	29.8
6	84	3.14	3.4	0.8	5.0	54	38.3
10	80	1.82	4.5	1.0	6.5	73	51.8
16	126	1.16	6.3	1.0	8.3	98	69.6
25	196	0.743	7.8	1.3	10.4	129	91.6
35	276	0.527	9.0	1.3	11.6	158	112
50	396	0.368	10.5	1.5	13.5	198	140
70	360	0.259	12.5	1.5	15.5	245	174
95	475	0.196	14.8	1.6	18.0	292	207
120	608	0.153	16.5	1.6	19.7	344	244

¹⁾ To DIN ISO 6722, Part 3.

²⁾ To DIN VDE 0298, Part 4.

5.2 Fuse

- 5.2.1 Every electrical circuit shall be provided with fuse designed for the circuit. In case of multiple circuits a common fuse shall be permitted, subjected to suitable current capacity per circuit depending upon the individual electric load.

The current carrying capacity of the fuse shall be :
Rated Current of Fuse = 1.5 times the Load Current of the Electrical Equipment

5.3 Terminals, Connectors & Elements

- 5.3.1 End terminations: All the ends shall be suitably crimped with lugs /soldered or fixed so as to withstand vehicle vibrations.
- 5.3.2 The interconnection shall be through couplers/junction boxes/ terminal blocks.
- 5.3.3 Suitable connectors shall be used for external areas which are exposed to atmosphere to avoid water /moisture ingress during use.

5.4 Safety requirements

- 5.4.1 Use of relays and other electrical elements shall be adopted where the current rating of the switches is not adequate.
- 5.4.2 The additional circuits shall not draw current more than specified by the manufacturer.
- 5.4.3 Where the voltage exceeds 100 Volts RMS (Root Mean Square) in one or more electrical circuit, a manually operated isolation switch which is capable of disconnecting the circuit(s) from the main electrical supply shall be provided and shall be located inside the vehicle. Alternatively, electrically operated battery cut off switch may be provided.”
- 5.4.4 No circuit provided by the vehicle manufacturer or type approved shall be modified.
- 5.4.5 The isolation circuit shall have provision for bypassing circuits supplying mandatory external vehicle lighting i.e. besides the main isolation switch, individual isolation switches shall be used in series with main isolation switch, each for internal lighting and external mandatory lighting.
- 5.4.6 Electrical cables shall be located such that no part can make contact with any fuel line or exhaust system subjected to excess heat. Suitable special insulation shall be provided where such electrical circuits are necessary.
- 5.4.7 Electrical conductors shall meet the requirement for flame resistance specified in para 6.8.

5.5 Batteries

- 5.5.1 All batteries shall be well secured and easily accessible.
- 5.5.2 The battery compartment shall be separated from the passenger compartment and if provided in driver’s compartment, it shall be covered and well ventilated.
- 5.5.3 Battery terminals shall be protected against short circuit risk.
- 5.5.4 Isolation Switch: A manually or electrically operated isolation switch, which is capable of disconnecting the battery terminal from the electrical circuit, shall be provided.

5.6 Electrical Wiring and Circuits

- 5.6.1 The circuit diagram for the bus provided by OE vehicle manufacturer shall not be tampered”

Table Standards Related to Electric Equipment & Wiring	
Description	Standard No.
Cables for Motor Vehicles	IS 2465 : 1984*
Cable Termination for Automobile Wiring Blade Type Connectors	IS 8395 : 1977 Part I*
Cable Termination for Automobile Wiring Bullet & Tube Type Connectors	IS 8395 : 1977 Part II*
Low Voltage Fuses	IS 13703 : 1993 Part I*
Colour Code of Electrical Wiring for major electrical circuits	IS 13313 : 1991 *
Cartridge Fuse links for Automobiles	IS 2577 : 1974*/JASO D601
Porcelain (Molded) Fuse links for Automobiles	IS 7528 : 1974*
Fuses for Automobiles	IS 4063 : 1982*
Piano key type switches for use in automobiles	IS 9433 : 1980*
Automobile Lamps	IS 1606 : 1979*
Electrical Circuits	IS 14381 : 1996*
*as amended from time to time.	

CHAPTER : 6

TEST METHODS

6.0 Design of Bus Bodies

All bus body builders may adopt suitable tools to design bus bodies for sufficient strength and for all the performance parameters specified in the code. Bus Body Builders may have their own analysis of bus body structures, done by use of Finite Element Analysis (FEA) or any other analytical tool to ensure sufficient bus body strength , for specific compliance to the strength requirements given at Clause 6.1. FEA is a detail design tool which basically saves time in designing and produces more accurate results. It is therefore recommended that bus body builders use design tools such as FEA, for verifying the strength of the bus body superstructure, either by themselves or from the authorised test agencies notified under Rule 126 of CMV(A)R, 1989. FEA would greatly help in assessing physical compliance to 6.1 at the design stage itself.

6.1 Body Structure Strength Test

All single deck buses of Type –II and Type – III category excluding Mini buses, shall meet requirements of Body Structure Strength as per AIS-031. All Double Deck Buses of Type-II and Type-III category shall meet the requirements of body structure strength as per AIS: 031, as and when the body structure strength requirements are finalized and incorporated in AIS-031.

- 6.1.1 Reserved
- 6.1.1.1 Reserved
- 6.1.1.2 Reserved
- 6.1.1.3 Reserved
- 6.1.1.4 Reserved
- 6.1.1.5 Reserved
- 6.1.2 Reserved
- 6.1.2.1 Reserved
- 6.1.3 Reserved
- 6.1.3.1 Reserved
- 6.1.4 Reserved
- 6.1.4.1 Reserved
- 6.1.4.1.1 Reserved
- 6.1.4.1.2 Reserved
- 6.1.4.1.3 Reserved
- 6.1.4.1.4 Reserved
- 6.1.4.1.5 Reserved
- 6.1.4.1.6 Reserved
- 6.1.4.2 Reserved
- 6.1.4.2.1 Reserved
- 6.1.4.2.2 Reserved

- 6.1.4.2.3 Reserved
- 6.1.4.2.4 Reserved
- 6.1.4.2.5 Reserved
- 6.1.4.2.6 Reserved
- 6.1.4.2.7 Reserved
- 6.1.5 **Roll-Over Test on a Body Section**
- 6.1.5.1 The test requirements, test procedure and acceptance criteria shall be as per AIS -031.
- 6.2 **Stability Test**
- 6.2.1 **Test Requirements**
- 6.2.1.1 When the surface on which the vehicle stands were tilted to both sides in turn at an angle of 28 degrees from the horizontal the vehicle shall not overturn.
- 6.2.2 **Test Condition**
- 6.2.2.1.1 For the purpose of test the vehicle, the unladen vehicle with addition of : Load equal to 75 kg (68 kgs standard mass of passenger + 7kgs luggage) shall be placed on each passenger and crew seat. Where vehicle is designed to carry standee passengers a load of 75 Kg. is placed with its centre of gravity at a height of 875 mm from the floor. The load shall be uniformly distributed.
- 6.2.2.1.2 Reserved
- 6.2.2.1.3 Alternatively a calculation method may be used to prove that the vehicle will not overturn under conditions specified in para 6.2.2.1.1. The Calculation method shall be approved by the test agency. The coach builder shall establish the validity of the calculation method to the satisfaction of the Test Agency on the basis of comparative test with a similar vehicle.
- 6.2.2.2 **Test Method**
- 6.2.2.2.1 The vehicle shall be subjected to test on a tilt test rig. Height of step used to prevent the vehicle from slipping side ways on the test rig shall not be greater than two third of the distance between the surface on which the vehicle stands and part of the rim of the wheel which is nearest to the surface in the untilted position. Ref. Fig. 8.
- 6.2.2.3 **Acceptance Criteria**
- 6.2.2.3.1 The stability of a vehicle shall be considered to comply with the requirement if the angle at which overturning occurs is greater than 28 degrees from the horizontal.
- 6.3 **Impact Strength for Bumpers**
- 6.3.1 The front and rear bumpers of the vehicle shall meet the requirements prescribed in relevant standard as and when notified.

6.4 Seat Requirements

6.4.1 Performance and Strength Requirements for Driver / Co-driver Seat

6.4.1.1 The driver / co-driver seat/ Front passenger seat shall meet the requirements specified in AIS-023, as amended from time to time.

6.4.2 Passenger Seat requirements

6.4.2.1 The passenger seats shall meet the requirements specified in AIS-023, as amended from time to time.

6.5 Power Operated Service Door

6.5.1 Test Requirements

6.5.1.1 The construction and control system of every power operated service door be such that a passenger is unlikely to be injured by the door or trapped between the door while closing. The door system shall meet the requirements defined in para 6.5.1.2 & para 6.5.1.3.

6.5.1.2 The closing of the door at the measuring point is resisted by the clamping force not exceeding 150 N, the door shall reopen automatically to its fullest extent and remain open until a closing control is operated. The clamping force shall be measured using a test bar of section 60mm High 30mm Wide and rounded at corners (R=5mm). The clamping force may be measured by the method specified in 6.5.2 or by any other equivalent method specified by the test agency. The peak clamping force may be higher than 150 N momentarily provided that it does not exceed 300 N. Alternatively, if the door can be easily reopened by hand, if the clamping force measured does not exceed 80 N when the door is between 30 and 120 mm ajar, and 150 N when is between 120 mm and 400 mm ajar with the energy supply on.

6.5.1.3 Whenever the doors are closed onto an object; the door reopens automatically to its fullest extent and remain open until a closing control is operated or the wrist or finger can be extracted without risk or injury to the passenger using test bar specified below:

- Test bar shall be so constructed such that it shall be tapered at one end over a length of 300 mm from 30 mm to a thickness of 5 mm.

6.5.2 Guidelines for measuring the closing forces of Power operated Doors

6.5.2.1 The closing of power –operated door is a dynamic process. When a moving door hits an obstacle, the result is a dynamic reaction force, the history of which (in time) depends on several factors. (e.g. the mass of the door, acceleration, dimensions).

6.5.2.2 Definitions

6.5.2.2.1 Closing force $F(t)$ is a time function, measured at the closing edges of the door (see para 6.5.2.3.2)

6.5.2.2.2 Peak forces F_p is the maximum value of the forces.

6.5.2.2.3 Effective force F_e is the average value of the closing force related to the pulse duration:

$$F_e = \frac{1}{T} \int_{t_2}^{t_1} F(t) dt$$

6.5.2.2.4 Pulse duration T is the time between t_1 and t_2 :

$$T = t_1 - t_2$$

Where

t_1 = threshold of sensitivity, where the closing force exceeds 50 N.

t_2 = fade away threshold, where the closing force becomes less than 50 N

This relation between the above parameters is shown below (as example only)

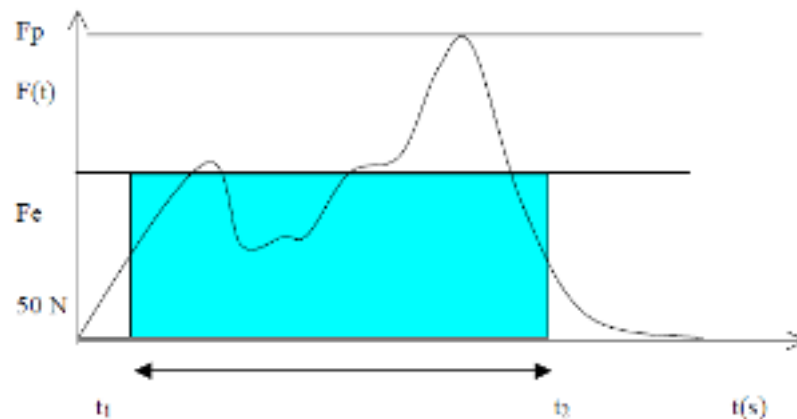

6.5.2.2.5 Clamping force F_c is the arithmetic mean value of the effective forces, measured at the same measuring point subsequently more times

$$F_c = \frac{\sum_{i=1}^n (F_e)_i}{n}$$

6.5.2.3 Measurements

6.5.2.3.1 Conditions of measurement

6.5.2.3.1.1 Temperature range 10 ° - 30 ° C.

6.5.2.3.1.2 The vehicle shall stay on a horizontal surface.

6.5.2.3.2 Measurement Points Shall be:

- At the main closing edge of the door,
- one in the middle of the door;
- one 150 mm above the lower edge of the door;

- 6.5.2.3.2.1 In case of the doors equipped with clamping prevention devices for the opening process; all the secondary closing edges of the door at the point which is considered to the most dangerous place of clamping.
- 6.5.2.3.3 At least three measurements shall be taken at each of the measuring points to determine the clamping force according to para 6.5.2.2.5.
- 6.5.2.3.4 The signal of the closing force shall be recorded by means of a low- pass filter with limited frequency of 100 Hz. Both the threshold of sensitivity and fade away threshold to limit the pulse duration shall be set at 50 N.
- 6.5.2.3.5 The deviation of the reading from the rated value shall not be more than $\pm 3\%$.

6.6 Door Components

6.6.1 Door and door components shall meet the standard specified in Rule 124 of CMVR, door locks shall meet requirements laid out in BIS Standards, Automotive Vehicles : locking systems and door retention components - general requirement IS 14225:1995, as amended from time to time and Automotive Vehicles Window retention and release system for buses - safety requirement as specified in 13944-1995, as amended from time to time.

6.6.2 Door latch

- 6.6.2.1 Door handle effort to unlatch the door shall be min. 30N and 55 N max. (optional specification).
- 6.6.2.2 Longitudinal Load : The door latch and striker assembly when tested as defined in IS 14225:1995 shall withstand a ultimate longitudinal load of 11 KN, when in fully latched position and 4.45 KN when in secondary latched position.
- 6.6.2.3 Transverse Load : The door latch and striker assembly when tested as defined in IS 14225:1995 shall withstand a ultimate transverse load of 8.9 KN, when in fully latched position and 4.45 KN when in secondary latched position.
- 6.6.2.4 Inertia Load : The door latch when contained in the door latched system (door latch, striker assembly, outside handle, key cylinder and connecting mechanism) and in fully latched position must remain in fully latched position when subjected to inertia load of 30 g in any direction. (ECE –R-42 & SAE J 839 July 82)

6.6.3 Door Hinges

- 6.6.3.1 Door hinge must be capable of withstanding an ultimate longitudinal load of 1135 Kgf and Transverse load of 910 Kgf.
- 6.6.3.2 *Longitudinal Load* : Door hinge system when subjected to test defined in SAE J July 82 shall be capable of withstanding an ultimate load of 11.1 KN.

6.6.3.3 *Transverse Load* :Door hinge system when subjected to test defined in SAE J 934 July 82 shall be capable of withstanding an ultimate load of 8.9 KN.

6.7 **Electrical Conductor Test**

6.7.1 **Principle**

6.7.1.1 This test consists of submitting specified test pieces of the electrical conductors, as installed in the vehicle, to a flame in order to evaluate their resistance to fire.

6.7.2 **Equipment**

6.7.2.1 The test equipment consists of:

6.7.2.1.1 **Test Enclosure**

6.7.2.1.1.1 The test enclosure consists of metallic screen with 3 faces:

- 1200 ± 25 mm height,
- 399 ± 25 mm width,
- 450 ± 25 mm depth.

The front face is open and the top and bottom is closed. The base not be metallic.

6.7.2.1.2 **Heat Source**

6.7.2.1.2.1 The heat source consists of a gas burner (Bunsen burner) of internal diameter between 9.5 mm and 10 mm. Its control is such that the length of the outer flame is approximately 125 mm and that of the inner flame approximately 40 mm.

6.7.2.1.2.2 The functioning of the burner is tested in the following manner: the base of the burner being horizontal, a naked copper wire of 0.71 ± 0.025 mm in diameter and having a free length of at least 100mm is introduced horizontally in to the flame, at 50mm above the top edge of the wire is situated above the far vertical edge of the burner (see Fig. 9) the time necessary to melt the wire shall not exceed 6 seconds, nor be less than 4 seconds.

6.7.3 **Test Pieces**

6.7.3.1 The test piece is formed by a piece of conductor 600mm ± 25mm long.

6.7.4 **Test Method**

6.7.4.1 The test piece is held vertically and placed in the middle of the test enclosure such that its lower end is approximately 50 mm from the base of the enclosure. For the test, the base of the burner ,forms an angle of 45 deg. With the axis of the test piece. The distance between the burner and the test piece must be such that the inner flame just touches the centre line of the sample(see Fig. 10). The flame must be applied about 100 mm above the lower end of the test piece for a continuous period T (seconds) given by the formula:

$$T = 60 + M/25$$

Where M is the mass in grams of the test piece of conductor per length of 600 mm.

6.7.5 **Results**

6.7.5.1 The observed phenomena are recorded in the test report, notably:

- the duration of the combustion
- the length of the charred section.

6.7.6 **Classification**

6.7.6.1 Based on the results obtained, the material will be classified as follows:

Category 1: Combustion is self- extinguished.

The upper end of the test piece is intact.

Category 2: Combustion is self- extinguished.

The upper end of the test piece is charred or affected.

Category 3: Combustion is not self- extinguished.

6.7.7 **Acceptance Criteria**

6.7.7.1 Only Category 1 conductors are permitted.

6.8 **Reserved**

6.9 **Illumination**

6.9.1 **Method of Measurement:**

6.9.1.1 Reserved

6.9.1.2 For measurements of illumination as per Para 4.1.2.4.1.2.3 and Para 4.1.2.4.1.3.3, a lux meter shall be employed. After switching on the individual lighting devices, in as installed condition, the lux meter shall be placed at the location specified in Para 4.1.2.4.1.2.3 and Para 4.1.2.4.1.3.3 and then the lux values shall be noted. These lux values shall fall within the prescribed limits.

6.9.2 **Cabin Lighting**

6.9.2.1 The illumination by lighting devices lighting up the cabin interior - should be sufficient enough to clearly distinguishing each component part of the cabin. Driver should be in a position to read signages written on the walls, door of the cabin. He should also be in position to read any instructions printed on paper.

6.9.2.2 The following lamps are to fall in this category:

- Cab lamp or courtesy lamp
- Locker lamp
- Electrical distribution lamp

6.9.2.3 The luminous flux of all the lamps provided for cabin lighting to light up the equipment, components and to read, shall not be less than 30 lux and shall not be more than 150 lux, when measured at 500 mm above the driver seat base.

6.9.3 Passenger area lighting

6.9.3.1 The illumination by lighting devices lighting up the passenger area should ensure reading of signages inside the passenger area and other important signs like emergency signs. The illumination should light up handles, latches, knobs, rods, hand-holds, etc., facilitating easy access to passenger.

6.9.3.2 The following lamps are to fall in this category:-

- Entrance lamps
- Passenger area lamps

6.9.3.3 The illumination of these lamps to light up the entrance and exit for the passengers and in general to light up the passenger compartment shall not be less than 50 lux. Illumination in passenger compartment shall be measured at any seating location of the bus and at 500 mm above the seat base.

6.10 Test methods, procedures and requirements in respect of items not covered in this code shall be separately notified time to time.

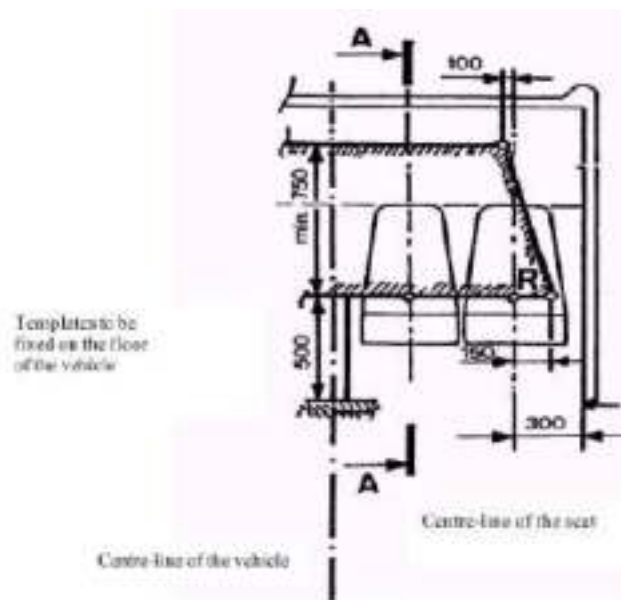

Figure 1
Residual Space after Lateral Intrusion

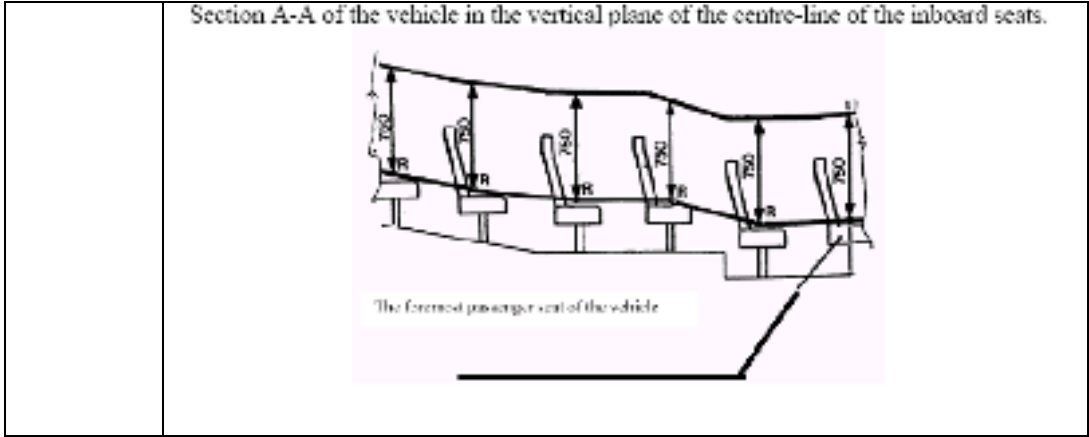
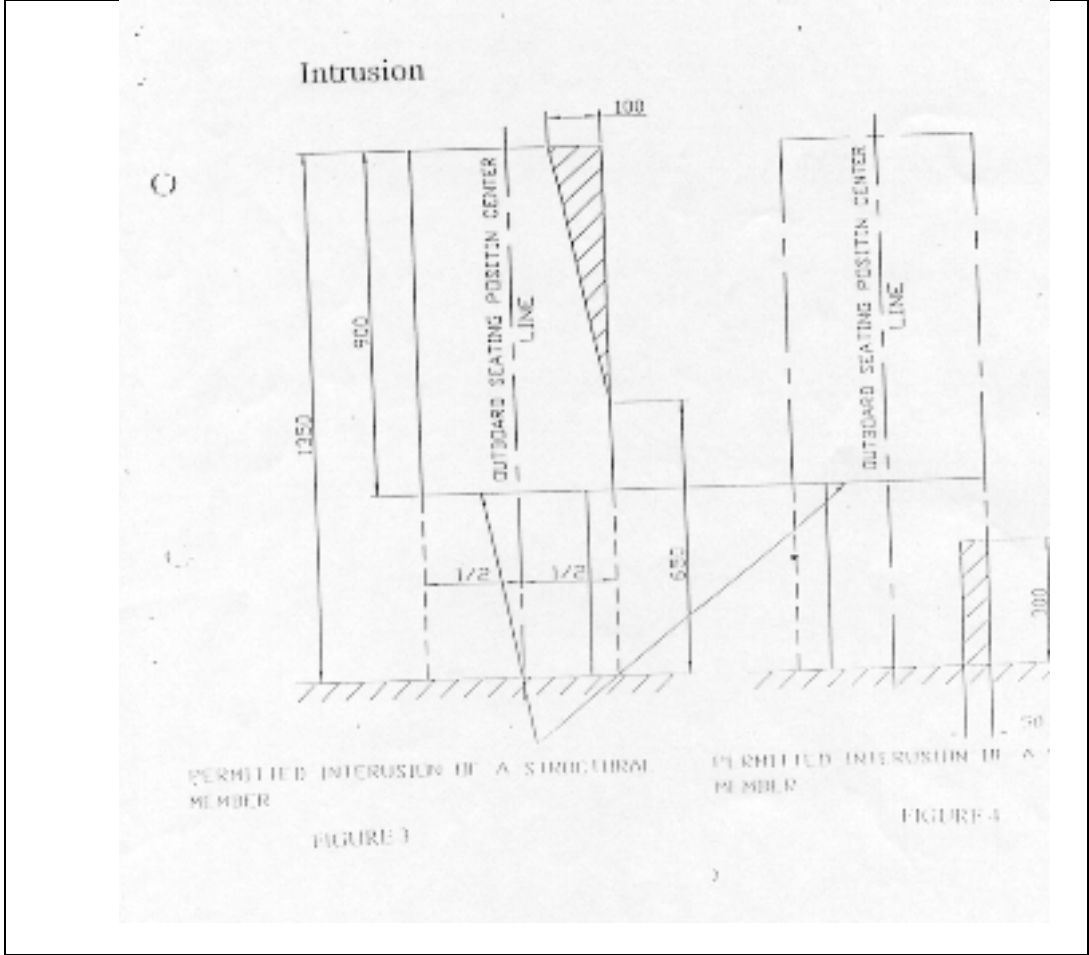

Figure 2
Residual Space after Longitudinal Intrusion



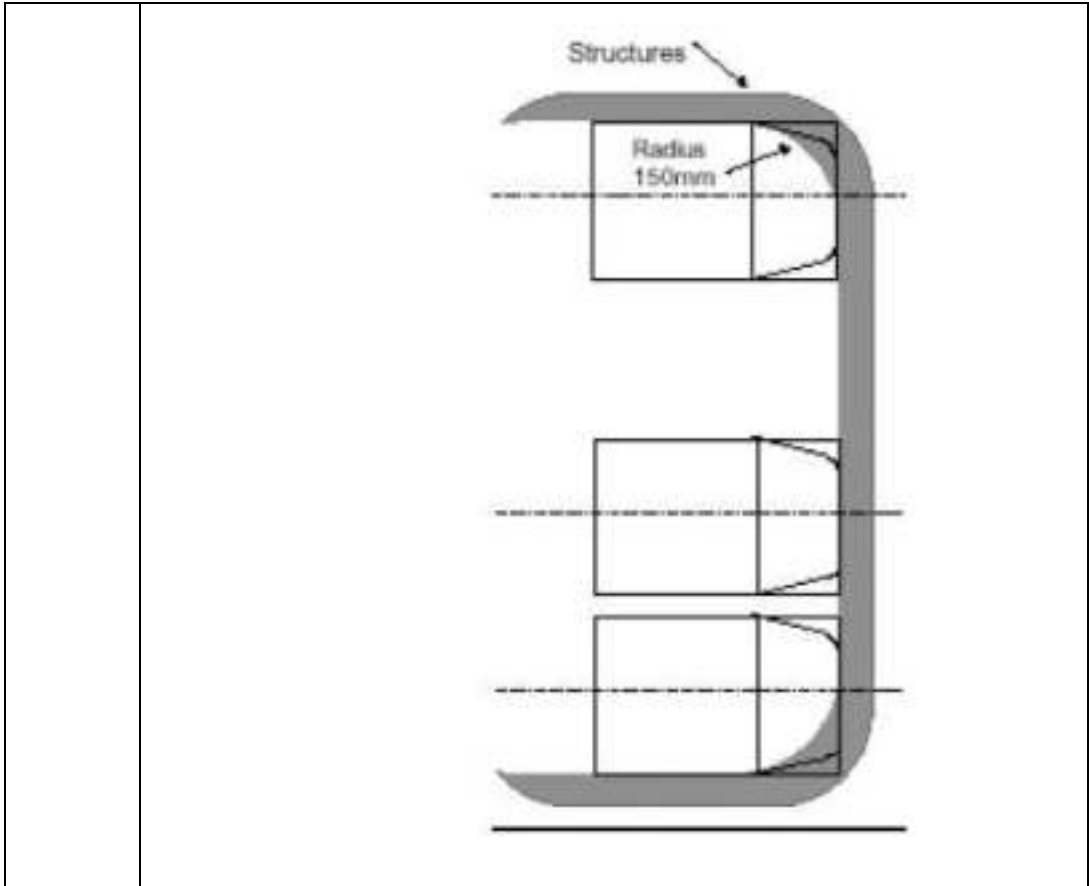

Figure 5
Permitted Intrusion at Rear Corner Seats View of the Prescribed Area of the Seat (Two seats at the Rear)

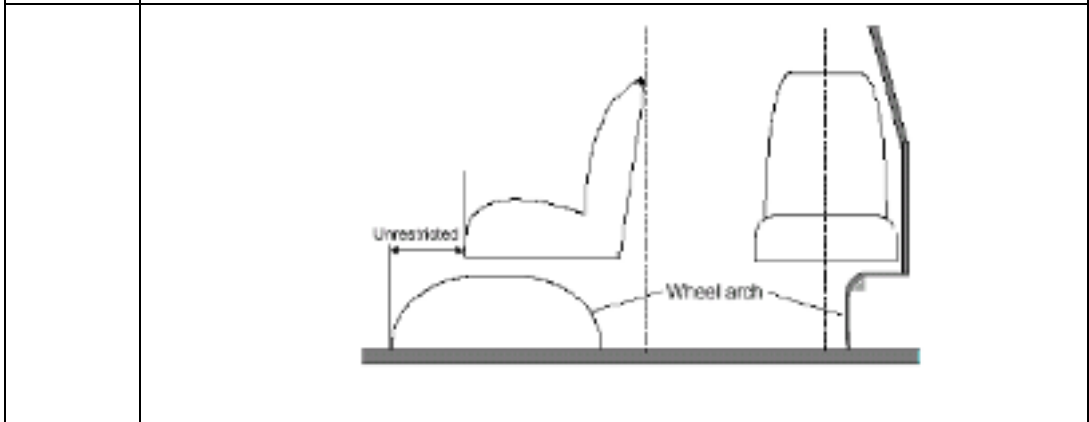

Figure 6
Permitted Intrusion of a Wheel Arch not extending beyond the vertical centre line of the side seat

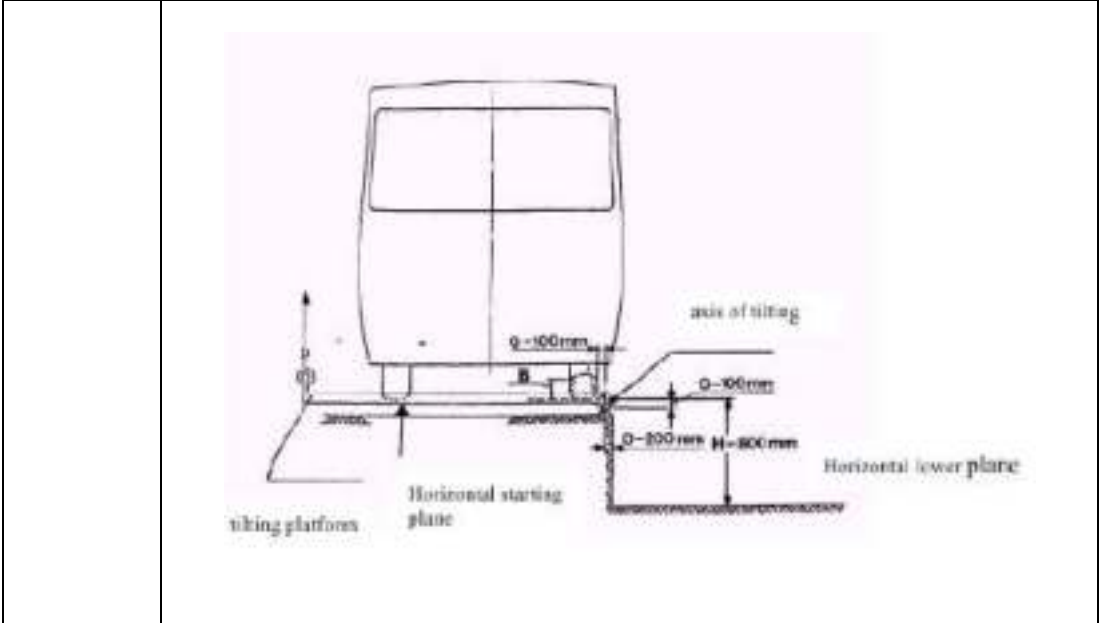

Figure 7
Test Set up for Roll-Over Test

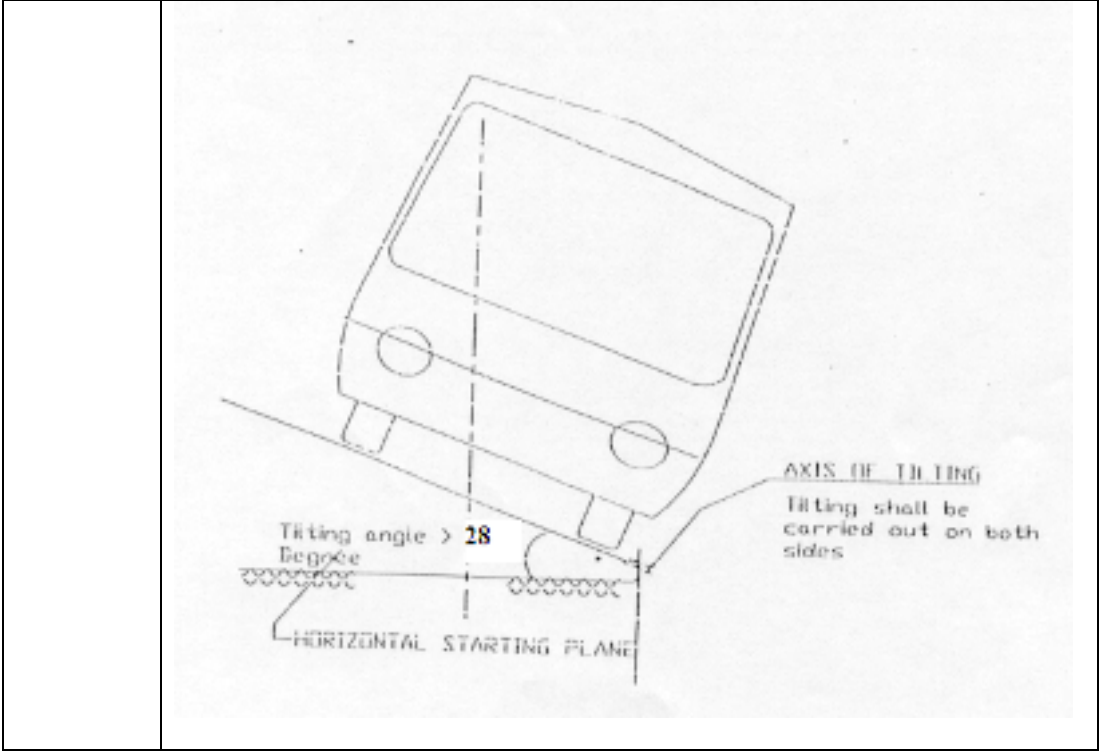

Figure 8
Stability Test and Tilt angle

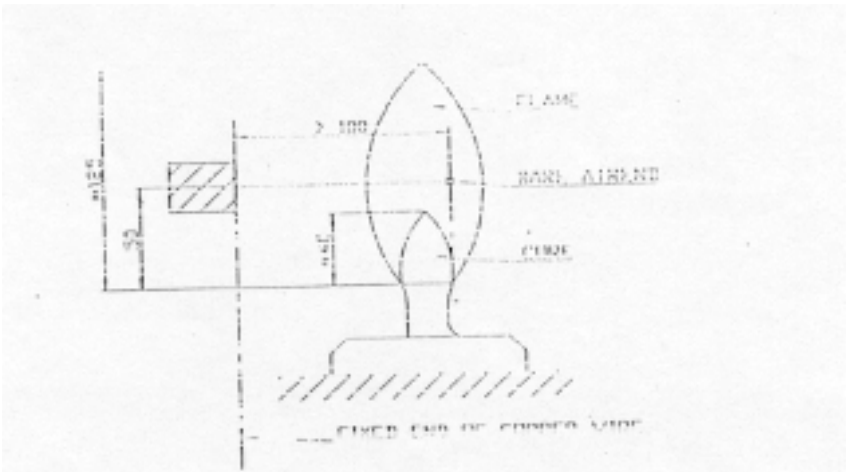

FIGURE 9

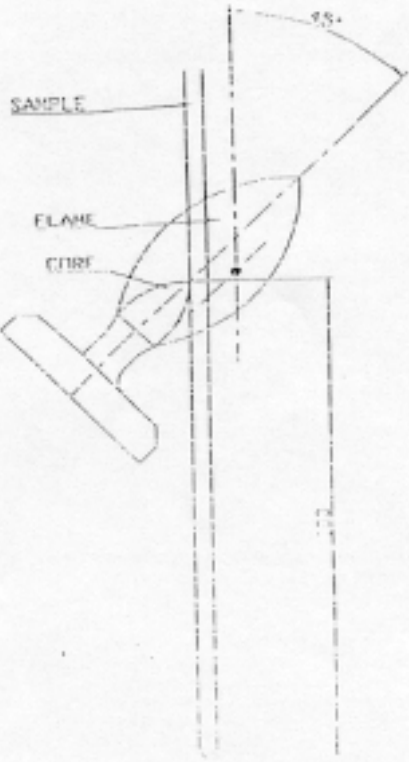

FIGURE 10

CHAPTER : 7
TYPE APPROVAL & COP PROCEDURE

7.1 SCOPE

7.1.1 The Type Approval Procedure specified in this code is applicable to buses with a seating capacity of 13 passengers or above.

7.1.2 The requirements of this code also apply to the following vehicles except in respect of those provisions* which are not compatible with the intended use and function of these vehicles :

A. High Capacity Buses like

- i. Double Decker Bus
- ii. Articulated Bus
- iii. Double Deck Articulated Bus

B Special Purpose Buses like -

- i. Sleeper Coach
- ii. School Bus
- iii. Tourist Bus
- iv. Prison vehicles
- v. Vehicles specially designed for the carriage of injured or sick persons (Ambulances)
- vi. Off road vehicles
- vii. Vehicle Designed for use by Police, Security and Armed Forces

* Provisions to be defined and notified separately.

7.1.3 The system for approval of Prototype (Rule 126) and Conformity to production (Rule 126A) to comply with provisions with respect to the safety, strength and technical requirements specified in the **Bus body building code** shall be based on the standards notified from time to time.

7.2 Procedure for Type Approval

7.2.1 **The Type Approval shall be applicable to the following provisions for which compliance is sought by the vehicle manufacturer or Bus Body Builder as the case may be.**

- (i) Complete Vehicle Type Approval (or)
- (ii) Bus Body Type Approval as a separate unit (or)
- (iii) Vehicle Type Approval fitted with the Bus Body which is already type approved
- (iv) Prototype Type Approval of Vehicle and other aggregates / units

7.3 **Application for Type Approval**

7.3.1 The application for type approval shall be submitted to the test agency by the Vehicle Manufacturer / Bus Body Builder , with the description of the vehicle type (s) or body type (s) or the vehicle type fitted with an already approved body. This application shall be accompanied by the following documents, as applicable to the provisions for which compliance is sought.

- a) List of provisions for which compliance is sought /to be established.
- b) All the relevant information specified in the format “Information on Technical Specifications” to be submitted by Bus Body Builder given in Table 22 and 22A of AIS-007(Rev.5):2014.
- c) Copies of certificates or test reports of compliance to various provisions, which may have already been obtained from other recognized Testing Agencies.
- d) Copies of test reports for other models/variants, if any, which can be used for establishing compliance of the model to be type approved, with a note explaining the details.
- e) Copy of certificate of incorporation of the manufacturer, if not already submitted.
- f) Publications available.

7.3.2 In case of body builders, who have adopted any type tested designs provided by the chassis manufacturers, the body builder shall provide the necessary details and drawings of the chassis manufacturer, to the test agency for their consideration.

7.4 **Type Approval of safety components / sub-assemblies**

7.4.1 In addition to the safety components notified under Rule 124 of CMVR, 1989, the Type Approval of passenger seats and seat mountings, window sub-assembly, power operated service door, door components, etc shall be obtained.

7.5 **Methods of Establishing Compliance**

7.5.1 Depending upon the provision, the compliance can be established by either comparison of the values declared in the Technical Specifications with those in the provisions of CMVR, or checking the fitment of part(s) on the vehicle or by testing, as applicable. Applicability of rules, method of establishing the compliance and details of the test procedures shall be as specified in the bus body building code.

7.5.2 Criteria for extension of approvals for certification of bus models / variants.

S. No.	Parameters	Extension Criteria
1	Any change in the Category of Bus	<ul style="list-style-type: none"> Separate application to be submitted by the manufacturer / bus builder.
2	Change in external and internal dimensions of bus	<ul style="list-style-type: none"> Extension can be given to those clauses pertaining to dimensions, also considering the compliance to CMVR.
Seating Layout and Gangway		
3	Seats	<ul style="list-style-type: none"> Can be extended based on AIS-023 report
4	Seating area	<ul style="list-style-type: none"> To be verified for Maximum seating and Minimum standee. To be verified for Maximum Standee and Minimum seating. 3 X 2 seating layout with Maximum Gangway would be the worst case.
		<ul style="list-style-type: none"> Increase in Overall Bus Width - No physical verification would be necessary. Reduction of Overall bus Width - Physical verification would be necessary.
5	Any change in parameters of AIS-052, where in the requirements are based on other standards	<ul style="list-style-type: none"> Change of such parameters can be considered for extension based on the reports complying to specified standards.
6	Door dimensions	<ul style="list-style-type: none"> Minimum dimensions of the particular category would be the worst case. Increase in number of doors - Physical verification would be necessary.
7	Internal height	<ul style="list-style-type: none"> If height of bus remains the same, standee bus is worst, extension can be provided for non-standee.
		<ul style="list-style-type: none"> If there is a decrease in the height of the bus, standee and non-standee provisions – Physical verification would be necessary.

Guard Rails		
8	Guard Rails	<ul style="list-style-type: none"> • Increase in guard rails more than 2 nos. - No physical verification would be necessary.
	Emergency exits	
9	Emergency exits / No. of emergency exits	<ul style="list-style-type: none"> • Increase in number of emergency exits, - Extension based on drawing. • Drawing showing the whole vehicle emergency plan.
	Steps	
10	Steps	<ul style="list-style-type: none"> • To be considered on case to case basis.
11	Access to service doors	<ul style="list-style-type: none"> • Type-I can be extended to Type-II. • Type-II can be extended to Type-III.
12	Step well	<ul style="list-style-type: none"> • Maximum depth of steps.
13	Cabin luggage rack	<ul style="list-style-type: none"> • Type-II and Type-III can be extended to all other buses other than Mini and Midi.
	Driver Work Area	
14	Driver work area	<ul style="list-style-type: none"> • In case of change in dimension of driver work area specification, physical verification would be necessary.
	Other Parameters	
15	Any change in parameters of AIS-052 , where in the requirements are other standards, like corrosion protections, wiring harness, safety critical components like safety glass, horns, rear view mirrors, Door locks and hinges, fuel tanks, window frames, lighting and signaling devices, seat padding material and upholstery	<ul style="list-style-type: none"> • Change of such parameters can be considered for extension based on reports / compliance to specified component or system level standard.
16	If the bus body remains same and the chassis on which the bus is made changes	<ul style="list-style-type: none"> • Extension will be provided based on the worst case criteria. All measurements with reference to ground should be confirmed.

7.6 Certificate of Compliance: (Type-approval)

- 7.6.1 After compliance is established for all the provisions, applicable to that model/variant(s), a Certificate of Compliance consolidating all applicable provisions shall be issued by the Testing Agency. The Brief Technical Specifications as declared by the manufacturer (Table 22 and 22A of AIS-007 (Rev. 5): 2014) shall be counter signed by the Testing Agency and shall be attached to the certificate of compliance.

7.7 Conformity of Production

- 7.7.1 COP shall be carried out at least once in 12 months by any of the testing agencies notified under Rule 126 of CMVR, 1989 or any other agency authorised by the government. A minimum of one unit shall be subjected to COP.

7.8 Accreditation of Bus Body Builders

- 7.8.1 All bus body building units shall be accredited by agencies notified by the Government. The accredited bus body building units shall meet the type approval requirements specified in para 7.2.

7.9 Non-conformity of Production

- 7.9.1 The accreditation granted to the Bus Body Building unit may be suspended or with drawn in case of non-conformity as per notified procedures for facility accreditation of Bus Body Builders, by the Ministry of Shipping, Road Transport and Highways.

APPENDIX - 1

(See 1.1.56)

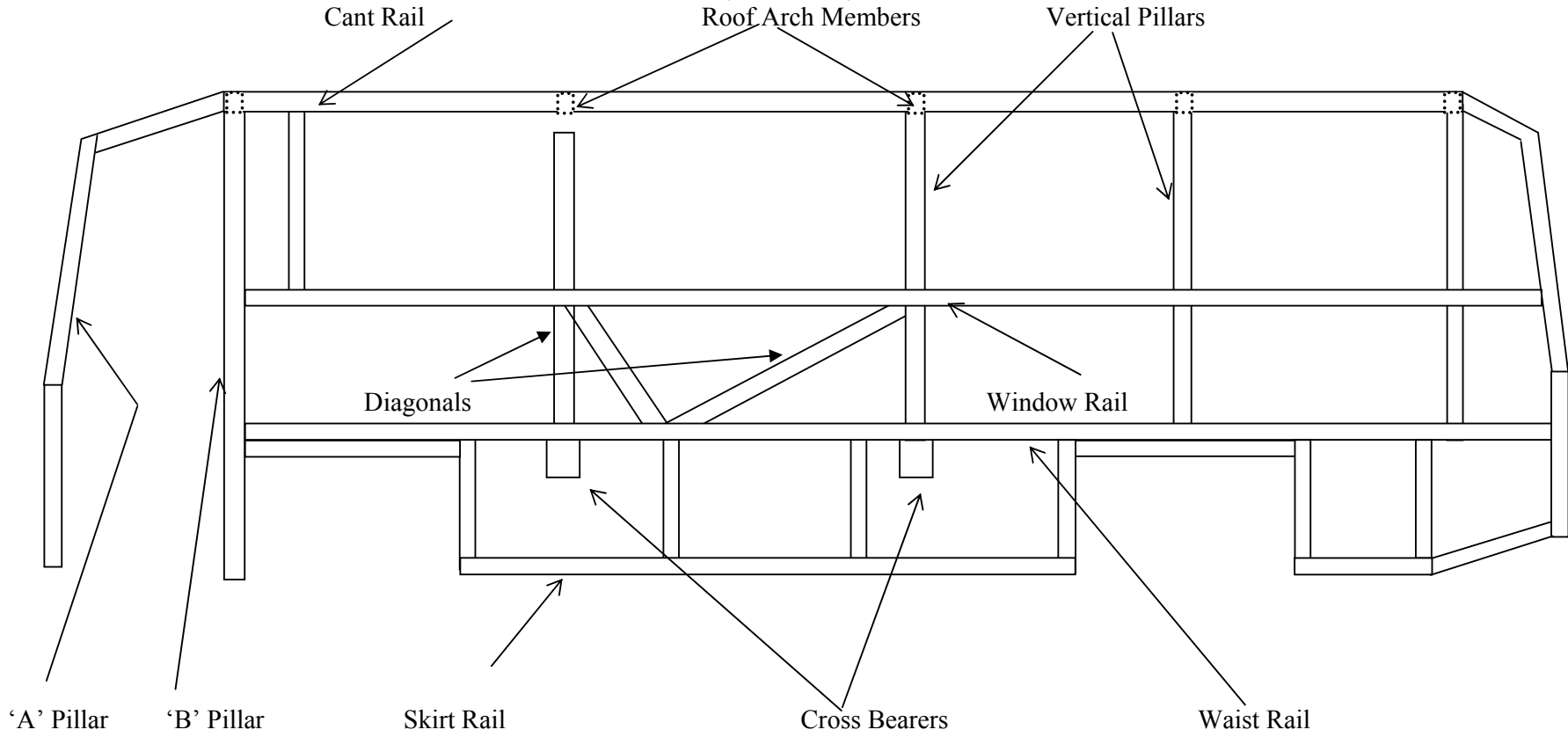

Body Structure – Nomenclature

APPENDIX - 2

(See 2.1.1)

Extract of Notification NO. GSR 221(E), issued by Ministry of Road Transport & Highways on 28th March 2001**(16) in rule 93,-**

- (a) in sub-rule (I),-
- (i) or the words "shall not Exceed" the 'words and figures "shall not exceed 2.6 meters.", shall be substituted;
 - (ii) clauses (i) and (ii) shall be omitted;
 - (iii) in the Explanation, for brackets and words "(when in operation)", the words brackets, figures and letters "rub-rail (rubber beading) having maximum thickness of 20mm on each side of the body" shall be substituted; .
- (b) for sub-rule(2), the following shall be substituted, namely:-
- "(2) 11le overall length of the motor vehicle other than trailer shall not exceed -
- (i) in the case of motor vehicle other than transport vehicle having not more than two axles, 6.5 meters;
 - (ii) in the case of transport vehicle with rigid frame having two or more axles, 12 meters;
 - (iii) in the case of articulated vehicles having more than two axles, 16 meters;
 - (iv) in the case of truck trailer or tractor trailer combination, 18 meters;
 - (v) in the case of 3 axle passenger transport vehicles, 15 m;
 - (vi) in the case of single articulated (vestibule type)passenger transport vehicle, 18 m.(Please see the conditions given in note below);
 - (vii) in the case of double articulate passenger transport vehicles, 25 meters (Please see the conditions given in note below).

Note

In the case of single articulated passenger transport vehicles of 18 meters' length and double '4 articulated passenger transport vehicles upto 25 meters, permission of the State Government shall be obtained regarding their plying on selected routes depending upon local road conditions, width, maneuverability of the vehicle in traffic, as deemed fit. These passenger transport vehicles will also be required to have a closed circuit TV system for proper visibility in and around the passenger transport vehicle by the driver to maintain safety. Intercom system shall also be provided in such passenger transport vehicle. In addition, the standing passenger will be allowed only on the lower deck of double articulated passenger transport vehicle.";

APPENDIX - 3
(See Note under 2.2.22.1)

MAJOR BUS SPECIFICATIONS / FEATURES

S.No	Description	TYPE OF BUSES										
		Type I (Urban & City)				Type II (Inter city)				Type III (Long Distance)		
		NDX	SDX	DLX	ACX	NDX	SDX	DLX	ACX	SDX	DLX	ACX
1	SERVICE DOORS											
	Minimum No. of Service Doors											
	One			✓	✓	✓	✓	✓	✓	✓	✓	✓
	Two	✓	✓									
	Minimum Width of Service Doors											
	Front Single Door 650 mm (Except Mini and Midi Buses. Ref. Para 2.2.1.1.7.1)	✓	✓	✓	✓	✓	✓	✓	✓	✓	✓	✓
	Front Double Door 1200 mm (Except Mini and Midi Buses. Ref. Para 2.2.1.1.7.1)	✓	✓									
	Rear door between the axles in case of rear engine 650 mm for Single Door (Except Mini and Midi Buses. Ref. Para 2.2.1.1.7.1)	✓	✓	✓	✓	✓	✓	✓	✓	✓	✓	✓
	Rear Double Door 1200 mm (Except Mini and Midi Buses. Ref. Para 2.2.1.1.7.1)	✓	✓									
	Height of Service Door											
1800 mm (Min.) (Except Mini and Midi Buses. Ref. Para 2.2.1.1.7.1)	✓	✓	✓	✓								
1650 mm (Min.) (Except Mini and Midi Buses. Ref. Para 2.2.1.1.7.1)					✓	✓	✓	✓	✓	✓	✓	

S.No	Description	TYPE OF BUSES										
		Type I (Urban & City)				Type II (Inter city)				Type III (Long Distance)		
		NDX	SDX	DLX	ACX	NDX	SDX	DLX	ACX	SDX	DLX	ACX
2	WINDOWS											
	<i>Minimum Width of Windows</i> 550 mm	✓	✓	✓	✓	✓	✓	✓	✓	✓	✓	✓
	Minimum Height of Windows											
	550 mm for standard bus and 450 mm for Midi and Mini buses			✓			✓	✓		✓	✓	
	1000 mm	✓	✓			✓						
	Sliding Type Window	✓	✓	✓		✓	✓	✓		✓	✓	
3	GUARD RAILS											
	Minimum Two Guard Rails	✓	✓	✓		✓	✓	✓		✓	✓	
4	EMERGENCY EXITS											
	Two Emergency Exits	✓	✓	✓	✓	✓	✓	✓	✓	✓	✓	✓
5	STEPS											
	Maximum Height of first step from ground											
	360 mm	✓	✓	✓	✓							
	400 mm					✓	✓	✓	✓	✓	✓	✓
	Maximum Height of next step											
	250 mm	✓	✓	✓	✓							
	350 mm					✓	✓	✓	✓	✓	✓	✓
6	MAXIMUM FLOOR HEIGHT											
	Based on type of operation and as demanded by the States	✓	✓	✓	✓	✓	✓	✓	✓	✓	✓	✓

S.No	Description	TYPE OF BUSES										
		Type I (Urban & City)				Type II (Inter city)				Type III (Long Distance)		
		NDX	SDX	DLX	ACX	NDX	SDX	DLX	ACX	SDX	DLX	ACX
7	GANGWAY											
	<i>Minimum Height</i> (1900 mm. Except for mini and midi buses. Refer para 2.2.8.1)	✓	✓	✓	✓	✓	✓	✓	✓	✓	✓	✓
	<i>Minimum Height for mini and midi buses.</i> 1750 for Standees and 1500 for non-standees mm. Refer para 2.2.8.1	✓	✓	✓	✓	✓	✓	✓	✓	✓	✓	✓
	Minimum Width											
	450 mm (Except for mini bus. Refer para 2.2.8.1)	✓	✓	✓	✓							
	350 mm (Except for mini non standee bus. Refer para 2.2.8.1)					✓	✓	✓	✓			
	300 mm									✓	✓	✓
8	SEATS											
	Seat Layout											
	2x2	✓	✓	✓	✓			✓	✓		✓	✓
	3x2					✓	✓			✓		
	2x1 (For Mini & Midi Buses, as per Para 2.2.11.2)	✓	✓	✓	✓	✓	✓	✓	✓	✓	✓	✓
	Seating Area/Space Per Passenger (Width X Depth)											
	400x350 mm (Min.)	✓	✓	✓	✓	✓	✓	✓	✓			
	450x400 mm (Min.)									✓	✓	✓
	Seat Spacing											
	650 mm	✓	✓	✓	✓							
680 mm					✓	✓	✓	✓	✓	✓	✓	

S. No	Description	TYPE OF BUSES										
		Type I (Urban & City)				Type II (Inter city)				Type III (Long Distance)		
		NDX	SDX	DLX	ACX	NDX	SDX	DLX	ACX	SDX	DLX	ACX
	Seat Base Thickness (Front x Rear)											
	90 x 60mm (Min.)	✓				✓						
	110 x 80 mm (Min.)		✓				✓			✓		
	130 x 100 mm (Min.)			✓	✓			✓	✓		✓	✓
	Seat Back Thickness											
	25 mm	✓	✓			✓						
	50 mm						✓			✓		
	75 mm							✓	✓		✓	✓
	Type of Seat Back											
	Fixed	✓	✓			✓	✓			✓		
	Reclining			✓	✓			✓	✓		✓	✓
9	DESTINATION BOARD											
	Minimum No. of Destination Board											
	Three	✓	✓	✓	✓							
	Two					✓	✓	✓	✓	✓	✓	✓
10	PAD MATERIAL (Recommended)											
	Fibre glass / Polymer moulded	✓										
	PU Foam	✓	✓			✓	✓					
	Rubberised coir	✓				✓				✓		
	Latex foam			✓	✓			✓	✓			
	Moulded PU Foam			✓	✓			✓	✓		✓	✓

S.No	Description	TYPE OF BUSES										
		Type I (Urban & City)				Type II (Inter city)				Type III (Long Distance)		
		NDX	SDX	DLX	ACX	NDX	SDX	DLX	ACX	SDX	DLX	ACX
11	UPHOLSTRY (Recommended)											
	PVC Rexin	✓				✓						
	Foam Rexin		✓				✓			✓		
	Tepstry cloth			✓	✓			✓	✓		✓	✓
	Velvet Cloth			✓	✓			✓	✓		✓	✓
12	OTHER FEATURES (Recommended)											
	Headrest			✓	✓			✓	✓		✓	✓
	Seat Arm			✓	✓		✓	✓	✓	✓	✓	✓
	Magazine Pouch			✓	✓		✓	✓			✓	✓
	Folding Tray For Eating										✓	✓
	Water Bottle Holding Fixture						✓	✓			✓	✓
	Individual Seat Row Fans			✓				✓			✓	
	Air Conditioning				✓				✓			✓
	Reading Lights				✓			✓	✓		✓	✓
	Cabin Luggage Carrier			✓	✓	✓	✓	✓	✓	✓	✓	✓
	Public Address System	✓										

APPENDIX - 4
(See Introduction)

List of Participants of the Sub-Committee Meetings *
Shri B. Bhanot, Chairman-CMVR-Technical Standing Committee

S. No	Name	Designation	Organisation
1.	Mr A S Lakra	Director Engg	ASRTU
2.	Mr Manuel Couthinho	Asst Supt	ACGL
3.	Mr U D Bhangale	Asst Director	ARAI
4.	Brig. S R Puranik	Director	ARAI
5.	Dr P R Sajjanpawar	Sr Dy Director	ARAI
6.	Mr A Akbar Badusha	Assistant Director	ARAI
7.	Mr B Ghosh	Sr Dy Director	ARAI
8.	Mr S K Raju	General Manager	Ashok Leyland
9.	Mr R Ramakrishnan	Tech Adviser	Ashok Leyland
10.	Mr C B S Menon	Sr Manager	Ashok Leyland
11.	Mr S K Patra	Asst Director (T&E)	ASRTU
12.	Mr P Arjuna	Executive Director	APSTRTC
13.	Mr V A Patnakar	DGM Tr. Engg	BEST
14.	Mr P K Samat	EETIB Tr. Engg	BEST
15.	Mr R M kanitkar	Dy Div Manager	Bajaj Tempo
16.	Dr S Padam	Director	CIRT
17.	Prof A V Sardesai	MoF-Member of Faculty	CIRT
18.	Mr P C Rao	Member of Faculty	CIRT
19.	Mr P Udaya Kumar	AMOF	CIRT
20.	Mr M L Gore	Member of Faculty	CIRT
21.	Mr M J Singh	Dev. Officer	DID, Min of Industries
22.	Mr S K Jain		DID, MOI
23.	Nr Dinesh Kumar	Manager	DTC
24.	Mr T C Madan	Sr Manager	DTC
25.	Mr Rakesh Arora	Project Director	District Rehabilitation Centre, New Delhi
26.	Mr N Menon	Sr Manager	Eicher Motors
27.	Mr S Venkataraman	Vice President	Hindustan Motors
28.	Mr M U B Rao	Manager-PE	Hindustan Motors
29.	Mr V K Jain	Sr Dev officer	Dept of Heavy Industry
30.	Mr Z A Mujawar	Dy General Manager	Mahindra & Mahindra
31.	Mr T G Venkataraman	Dy General Manager	Mahindra & Mahindra
32.	Mr V B Sankpal	Suppt. (R&D)	MSRTC
33.	Mr Praful Desai	Director	Neoline Enterprises
34.	Mr Ram Mohan	Consultant	SIAM

S.No	Name	Designation	Organisation
35.	Mr K K Gandhi	Sr Adviser	SIAM
36.	Dr Koshy Cherail	Asst Director	SIAM
37.	Ms Jyotika Dubey	Executive Officer	SIAM
38.	Mr Sumit Sharma	Executive Officer	SIAM
39.	Mr K S Wilkhu	Director (Engg&mkt)	Sutlej Motors Ltd
40.	Mr B S Devgun	Executive Director R&D	Swaraj Mazda
41.	Mr Ajinkya Naik	Executive Asst to MD	Sai Service Station Ltd
42.	Mr V L Abhyankar	Zonal Sales Manager	Tata Engg
43.	Mr P K Kamat	Div Manager	Tata Engg
44.	Mr Bharat Dhruv	Sr Manager	Tata Engg
45.	Mr Anupam Singh	Sr Manager	Tata Engg
46.	Mr K E Takavale	General Manager	Toyota Kirloskar
47.	Mr P N Rangan	Tech Adviser	Volvo
48.	Mr M N Srivastava	Asst Director	VRDE

Co-ordinator

Mr. A. Akbar Badusha

Sr. Dy. Director

The Automotive Research Association of India, Pune

Note : Though utmost care has been taken to include names of all the participants of Sub-Committee meetings, however, names of some of the participant might have been missed inadvertently.

* At the time of formulation of AIS-052(Rev.1).

APPENDIX - 5
(See Introduction)

**List of Participants for the Meeting to discuss revision of
AIS-052- Code of Practice of Bus Body Design and Approval held on
30th July 2007 at ARAI ***

Shri. Shrikant R. Marathe, Chairman-Automotive Industry Standards Committee

S.No	Name	Designation	Organisation
1.	Mr. S.M. Karlekar	Chief Engineer Transport	BEST
2.	Mr. S.R. Deshpande	Superindent (Inspector of Bodies)	BEST
3.	Mr. M.S. Sellandi	Jt. Managing Director	Metropolitan Transport Corporation(MTC), Chennai
4.	Mr. G.J. Moses	General Manager – Technical	Metropolitan Transport Corporation(MTC), Chennai
5.	Mr. S. Ramamurthy	General Manager - Technical	Metropolitan Transport Corporation(MTC), Chennai
6.	Mr. S.A.M. Shaik	Technical Officer	VRDE
7.	Mr. D.P.Saste	Scientist E	CIRT
8.	Mr. A. Akbar Badusha	Sr. Assistant Director	ARAI
9.	Mr. S.M. Haragapurkar	Deputy Director	ARAI
10.	Mr. S.S.Sandhu	Deputy Director	ARAI
11.	Mr. S.Raju	Sr.Deputy Director	ARAI
12.	Ms. Rashmi Urdhwareshe	Deputy Director	ARAI
13.	Mr. A.S.Bhale	Assistant Director	ARAI
14.	Mr. K.K.Gandhi	Executive Director (Technical)	SIAM
15.	Mr. R. Devarajan	Special Director	Ashok Leyland Ltd.,
16.	Mr. C.B.S.Menon	Deputy General Manager	Ashok Leyland Ltd.,
17.	Mr. S.Ravishankar	Sr.General Manager	Tata Motors Ltd.,
18.	Mr. P.K.Banerjee	Asst. General Manager	Tata Motors Ltd.,
19.	Mr. N.Ilango	Project Manager	Tata Motors Ltd.,
20.	Mr. Z.A.Mujawar	General Manager	Mahindra & Mahindra Ltd.,
21.	Mr. N.J.Khandare	General Manager	Mahindra & Mahindra Ltd.,
22.	Mr. Rajeev Dave	Manager	Mahindra & Mahindra Ltd.,

S.No	Name	Designation	Organisation
23.	Mr.R.M.Kanitkar	Chief Engineer	Force Motors Ltd.,
24.	Mr.S.R.Agrhari	Deputy General Manager	Swaraj Mazda Ltd.,
25.	Mr. Kulbir Singh Gosal	Deputy Manager	Swaraj Mazda Ltd.,
26.	Mr. Pankaj Yadav	Manager	Eicher Motors Limited
27.	Mr. S.V.Suderson	Sr. Manager	Volvo India Pvt. Limited

Co-ordinator
Mr. A. Akbar Badusha
Sr. Dy. Director
The Automotive Research Association of India, Pune

* At the time of formulation of AIS-052 (Revision-1).